

NATIONAL INSTITUTE OF TECHNOLOGY KARNATAKA, SURATHKAL

POST SRINIVASNAGAR, MANGALURU – 575 025 (D K)

Phone: (0824) 2474 000. Fax: (0824) 2474 033/ 2474 039

E-mail: registrar@nitk.ac.in

Website: http://www.nitk.ac.in

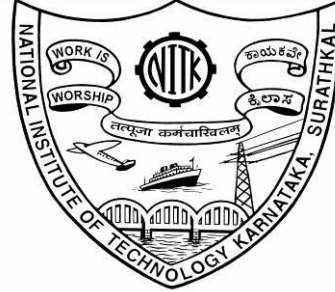

TENDER [BID] DOCUMENT

[Technical bid and Price bid system]

Name of the work : Manufacturing, Supply and installation of furniture to e – Library Complex, NITK, Surathkal

Tender No: 08 / NITK / e-Library /FURN / OH-35 / 2020-21 / B4 dated: 29.06.2020

Start date for 'Request for Tender' and submission of e-tender	: 29-06-2020 15:00hours onwards.
End date for request of 'Tender Document'	: 20-07-2020 up to 14:30 hours
Last (End) date for submission of e-tender	: 20-07-2020 up to 15:30 hours
e-tender opening date (Technical bid)	: 20-07-2020 at 16:00 hours
Estimated amount put to tender	: ₹ 24,66,713/-
Cost of Tender document	: Nil
Earnest Money deposit (EMD)	: ₹49,334/-
Time allowed for completion of work (including rainy season)	: 45 days

Note: EMD shall be remitted through RTGC/ NEFT and its acknowledgement shall be uploaded in e-procurement portal while submitting e-tenders. Bidders registered with MSME/ NSIC shall upload their registration certificate.

Sl. No.	Description	Page no.
1	Notice Inviting e-Tenders, Procedure for submission of Tenders	03 - 07
2	Integrity pact & Integrity pact agreement	08-14
3	Checklist – Documents to be kept ready for uploading.	15
4	General instructions to the bidder, General terms and conditions	20-23
5	Clauses of Contract	24-34
6	Special Conditions of Contract	35-38
7	Definitions and interpretations	39
8	Approved brands of materials	40
9	Format: Format for furnishing similar works done	41
10	Format: Format for similar works in hand	42
11	Format of Affidavit to be submitted (Eligibility Criteria 10.7 & 10.8)	43
12	Format for furnishing Indemnity bond (by the successful bidder only)	44
13	Format of Letter of Intent	45
14	Format of agreement	46
15	Format of Work Order	47
16	Format for submission of details of the bank account of the bidder	48
17	Drawings	49-58
Price bid (Only format – bid to be quoted on e-Procurement portal)		
18	Price bid – Specifications and qualities	59-62



NATIONAL INSTITUTE OF TECHNOLOGY KARNATAKA, SURATHKAL
(An Autonomous Institute of the Ministry of HRD, Govt. of India)
POST SRINIVASNAGAR, MANGALURU – 575 025



Phone: (0824) 2474 000. Fax: (0824) 2474 033/ 2474 039

E- mail: registrar@nitk.ac.in

Website: <http://www.nitk.ac.in>

No. 08 / NITK / e-Library /FURN / OH-35 / 2020-21 / B4

Date: 29- 06 - 2020

NOTICE INVITING e-TENDERS [On e-Procurement mode]

1. National Institute of Technology Karnataka, Surathkal (in short - NITK, Surathkal; hereinafter referred as the “Institute”) is an autonomous Educational Institute of the Ministry of Human Recourses Development, Government of India, imparting technical and science education. National Institute of Technology Karnataka, Surathkal is one of the “Institutes of National Importance” notified by the Govt. of India under the NITSER Act – 2007 (Act No. 29 of 2007). The Institute is fully funded by the Government of India; and is governed by NITSER Act.
2. The Institute hereby invites e-tenders for the below mentioned work from the eligible registered contractors of KPWD/ CPWD/Dept. of Electrical Inspectorate of appropriate class:

Tender No.	Name of Work	Estimate amt. put to tender	E M D	Cost of tender document	Eligibility class of contractor	Time allowed for completion (including rainy season)
[1]	[2]	[3]	[4]	[5]	[6]	[7]
08 / 20- 21	Manufacturing, Supply and installation furniture to e-Library Complex NITK, Surathkal	₹ 24,66,713/- (Including GST at 18%)	₹49,334/-	Nil	CPWD class I (Furniture)/ Registered Furniture manufacturers/ Registered Furniture dealers	45 days

The e-tenders invited are on techno-marine quality [Exterior grade] confirming to IS:710 basis on e-Procurement mode. Any tender, if submitted off-line (Manually) shall not be entertained. **The intending bidders shall submit their bids through MHRD web e-Tendering portal: <https://mhrd.euniwizarde.com>**

3. The work mainly involves furniture such Chairs, Modular Work Station Tables: (Open Desking), Asstt. Librarian Table, Visitor Chair, S.D.U 1200 HT, Property Counter Help Desk Table, Help Desk Chair, Coffee Table Round, Coffee Table Rectangle, Cafeteria Chairs, Reading Tables, Reading Table (Plektrom Table), Round Table, Podium Chairs, Podium Tables, Conference Table, Tele Conference Table.

4. **Detailed procedure for submission of e-tenders is available in the website <https://mhrd.euniwizarde.com>**

The intending bidders will have to pay (on-line) a non-refundable Tender Processing fee at the rate of 0.1% of the estimated value put to tender plus GST as applicable [subject to a minimum of ₹750 + GST and maximum of ₹7,500 + GST per event] to the service provider M/s ITI Limited (A GOI Enterprise).

5. The calendar of events of e-Tender are as follows:
 Start date for ‘Request for Tender’ and submission of e-tender : 29-06-2020 15:00hours onwards.
 End date for request of ‘Tender Document’ : 20-07-2020 up to 14:30 hours
 Last (End) date for submission of e-tender : 20-07-2020 up to 15:30 hours
 e-tender opening date (Technical bid) : 20-07-2020 at 16:00 hours

Meaning of “End Date for Request tender document”: The bidders can submit their tender right from the ‘Start date for submission of e-tender’. However, if any bidder wishes to submit his tender, first he should “Request the

tender” in <https://mhrd.euniwizarde.com> and then proceed for bid submission in MHRD portal. Before the stipulated time i.e. “End date for Request tender document”, bidder should request tender to participate in bid. If request is not submitted, the bidder cannot submit his bid at the last moment.

6. **Earnest Money Deposit (EMD):** EMD should be remitted in favour of **NITK, Surathkal**. **EMD shall be paid through online. Bidder shall select the payment option as “E-Payment” to pay the EMD** wherever applicable and enter details of the instrument.

EMD in any other form is not acceptable. Tenders received without the EMD will be rejected (except in the case of NSIC/MSME enlisted bidders). The EMD of successful bidder shall be retained (and shall be adjusted to the Security deposit). EMD shall bear no interest. EMD of the bidder is liable for forfeiture as per the terms of the tender document in case of any default. The EMD of unsuccessful bidders will be returned by the Institute within 30 days from the date of acceptance of evaluated lowest bid.

7. **Performance guarantee:** The successful bidder shall deposit a performance guarantee of 5% of the bid amount (as accepted) through RTGS/NEFT/ in the form of Bank Guarantee (in approved format) / Demand Draft / FDR of any scheduled bank drawn in favour of the **Director, NITK, Surathkal** payable at Surathkal, on intimation before executing the Contract Agreement.

8. **Security deposit:** The successful bidder shall deposit a further **security deposit of 2.5%** of the bid amount (as accepted) through RTGS/NEFT/ in the form of Bank Guarantee (in approved format) / Demand Draft / FDR of any scheduled bank drawn in favour of the **Director, NITK, Surathkal** while executing the Contract Agreement **OR** the same shall be deducted from the contractor’s work bills.

9. The agencies enlisted under NSIC/MSME are requested to note that the present notice inviting e-tenders is **not** for the “Supply of Goods readymade”, but for engaging a contractor under **works contract for manufacturing and supply of items as per the specific requirement of the Institute. If agencies enlisted under NSIC/MSME are interested in participating in the e-tender, they may participate subject to fulfillment of the conditions of this notice inviting e-tenders. However, they are exempted from paying EMD while submitting their e-tender.**

10. **Minimum eligibility criteria for qualifying in Technical bid:**

The intending bidder must satisfy all the following requirements for qualifying in the technical bid. Self-attested copy of the related document should be scanned and uploaded while submitting e-tenders:

- 10.1 The bidder must be a registered contractor of Central PWD of Class I category (Furniture) or Registered Furniture manufacturers or Registered Furniture dealers. A self-attested copy of registration in case of CPWD contractors; registration under Shops and Marine quality [Exterior grade] confirming to IS:710 Establishment Act (or similar) evidencing registration as Furniture manufacturer/ Furniture dealer should be uploaded to e-Procurement portal while submitting e-tenders.
- 10.2 The bidder must possess GST registration – a self-attested copy should be uploaded.
- 10.3 The bidder must possess PAN registration with Income Tax department – a self-attested copy should be uploaded
- 10.4 The bidder must be registered under Employees Provident Fund (EPF) Act – a self-attested copy should be uploaded (if not applicable as per the said Act-enclose exemption declaration duly signed and stamped).
- 10.5 The bidder must be registered under Employees State Insurance (ESI) Act – a self-attested copy should be uploaded (if not applicable as per the said Act-enclose exemption declaration duly signed and stamped).
- 10.6 The agency must have the experience of having **successfully completed** similar work as follows during the past seven financial years (Enhancement at simple 7% per annum shall be considered to bring it to the current costing level) in any Central Government department/ State Government department/Central or State Government undertakings/ Central or State government autonomous bodies/Public or Private Sector Units/ Private firms:
- (i) **At least three single similar works, each work costing not less than ₹ 9.86 Lakh; OR**
 - (ii) **Two similar works, each work costing not less than ₹14.80 Lakh; OR**
 - (iii) **One similar work of not less than ₹ 19.73 Lakh.**

Similar work means manufacturing, supply and installation of Furniture items.

Self-attested copy of Work Experience certificate issued from Central Government department/ State Government department/Central or State Government undertakings/ Central or State government autonomous bodies/Public or Private Sector Units/ Private firms (**with a copy of TDS certificate in case of Private firms**) should be uploaded.
Relaxation of norms applicable to startup and MSE as per GOI order.

- 10.7 The bidder should not have abandoned or suspended any awarded work of any organization during the past five financial years. Relevant proof in the form of a duly sworn affidavit (as per the format in the tender document) in this respect should be signed and uploaded (and the original be furnished by the successful bidder while executing the contract agreement).
- 10.8 The agency should not have been blacklisted / debarred for competing by any organization during the past five financial years. Relevant proof in the form of a duly sworn affidavit (as per the format in the tender document) in this respect should be signed and uploaded (and the original be furnished by the successful bidder while executing the contract agreement).
11. Time is the essence of the contract and hence the work should be completed within the stipulated timeframe. Bidders, who in their opinion have the capacity to complete the work within the stipulated timeframe, shall only participate in the e-tender. **Participation in the e-tender shall be deemed as the bidder has the capacity to complete the work within the stipulated timeframe.**
12. Quoting rate for all the items is a must. **The lowest tender will be determined based on the total of all the items.** If the rate is not quoted for any of the item(s) or quoted as zero for whatever the reason, the same shall be executed at zero cost.
13. A Works Contract Agreement shall be drawn with the successful bidder. Price escalation clause is not applicable to this work. Any further details required may be obtained from the office during the office hours.
14. The Institute reserves the right of rescheduling the calendar of events, make modifications to tender document before its submission by the bidder, cancelling the tender or relaxing any terms of the tender or rejecting all the tenders.
15. Warranty Period 5 Years.
16. In-house manufacturing and testing facility should be available.

Registrar
NITK, Surathkal

Copy to:

1. Superintending Engineer, PW, P& IWTD Mangaluru Circle, Mangaluru – 1
2. Executive Engineer, Central PWD, Mysuru Central Division, Siddarthnagar, Mysuru – 570 011
3. Executive Engineer, KUWS and D Board, Bendore, Mangaluru – 1
4. Executive Engineer, Construction, NMPT, Panambur, Mangaluru – 11
5. Executive Engineer, ZillaParishath Engineering Division, Mangaluru – 575 006
6. Executive Engineer, PW, P&IWTD Division Office, PWD, Mangaluru – 575 001.
7. Commissioner, Mangaluru City Corporation, Labagh, Mangaluru - 575003
8. Commissioner, Mangaluru City Corporation, Surathkal Sub-Office, Post Surathkal – 575 014.
- With a request to display the notification on the notice board.

Copy to: Central Public Procurement Portal (eprocure.gov.in)

Copy to:

- | | | | |
|------------------------|---------------------------|------------------------|---------------------------------|
| (1) Dean (P&D); | (2) Dean (FW); | (3) Registrar; | (4) Joint Registrar; |
| (5) CVO, NITK; | (6) Internal Auditor; | (7) Resident Engineer; | (8) Faculty i/c of Est.& Works; |
| (9) F. I of Ele.Works; | (10) Accounts Suptd. - 1; | (11) A1 Asst.; | (12) Cashier- for information. |

Copy to: Shri P G Mohanan, CCC with a request to upload the notification to the Institute website.

Copy to Librarian– for information.

Copy submitted to the Tables of Director and Deputy Director – for kind information

PROCEDURE FOR SUBMISSION OF E-TENDER

The bidders are required to submit soft copies of their bid electronically on the e-Wizard Portal using valid Digital Signature Certificates. Below mentioned instructions are meant to guide the bidders for registration on the e-Wizard Portal, prepare their bids in accordance with the requirements and submit their bids online on the e-Wizard Portal. For more information bidders may visit the e-Wizard Portal <https://mhrd.euniwizarde.com>

1. REGISTRATION PROCESS ON ONLINE PORTAL:

- 1.1 Bidders to enroll on the e-Procurement module of the portal <https://mhrd.euniwizarde.com> by clicking on the link "Bidder Enrolment" as per portal norms.
- 1.2 The bidders to choose a unique username and assign a password for their accounts. Bidders are advised to register their valid email address and mobile numbers as part of the registration process. These would be used for any communication from the e-Wizard Portal.
- 1.3 Bidders upon enrolment shall register their valid Digital Signature Certificate (DSC: Class II or Class III Certificates with signing key usage) issued by any Certifying Authority recognized by CCA India with their profile.
- 1.4 Only one valid DSC should be registered by a bidder. Please note that the bidders are responsible to ensure that they do not lend their DSCs to others which may lead to misuse. Foreign bidders are advised to refer "DSC details for Foreign Bidders" for Digital Signature requirements on the portal.
- 1.5 Bidder then logs in to the site through the secured log-in by entering their user ID/password and the password of the DSC / e-Token.
- 1.6 Possession of a Valid Class II/III Digital Signature Certificate (DSC) in the form of smart card/ e-Token is a prerequisite for registration and participating in the bid submission activities through <https://mhrd.euniwizarde.com>. Digital Signature Certificates can be obtained from the authorized certifying agencies, details of which are available in the web site <https://mhrd.euniwizarde.com> under the link 'DSC help'.

2. TENDER DOCUMENT SEARCH:

- 2.1 Various built-in options are available in the e-Wizard Portal which is further synchronized with CPP Portal to facilitate bidders to search active tenders by several parameters. These parameters include Tender ID, organization, location, date, value, etc.
- 2.2 There is also an option of advanced search for tenders, wherein the bidders may combine a number of search parameters such as organization name, a form of contract, location, date, other keywords, etc. to search for a tender published on the Online Portal.
- 2.3 Once the bidders have selected the tenders they are interested in, they may download the required documents/tender schedules. These tenders can be moved to the respective 'My Tenders' folder. This would enable the Online Portal to intimate the bidders through SMS / e-mail in case there is any corrigendum issued to the tender document.
- 2.4 The bidder should make a note of the unique Tender ID assigned to each tender, in case they want to obtain any clarification/help from the Helpdesk.

3. BID PREPARATION:

- 3.1 Bidders should take into account any corrigendum published on the tender document before submitting their bids.
- 3.2 Please go through the 'Notice inviting tender' and the 'Tender Document' carefully to understand the documents required to be submitted as part of the bid.
- 3.3 Please note down the number of cover in which the bid documents have to be submitted, the number of documents - including the names and content of each of the document that needs to be submitted. Any deviations from these may lead to rejection of the bid.
- 3.4 Bidder, in advance, should get ready the bid documents to be submitted as indicated in the tender document/schedule and generally, they can be in PDF / XLS / PNG, etc. formats. Bid documents may be scanned with 100 dpi with black and white option

4. BID SUBMISSION:

- 4.1 Bidder to log into the site well in advance for bid submission so that he/she uploads the bid in time i.e. on or before the bid submission time. Bidder will be responsible for any delay due to other issues.

- 4.2 The bidder to digitally sign and upload the required bid documents one by one as indicated in the tender document.
- 4.3 Bidder to select the payment option as "Online" to pay the EMD wherever applicable and enter details of the instrument.
- 4.4 A standard BoQ (Bill of Quantity) format has been provided with the tender document to be filled by the bidders. Bidders to note that they should necessarily submit their financial bids in the prescribed format only and no other format is acceptable.
- 4.5 The server time (which is displayed on the bidders' dashboard) will be considered as the standard time for referencing the deadlines for submission of the bids by the bidders, the opening of bids, etc. The bidders should follow this time during bid submission.
- 4.6 All the documents being submitted by the bidders would be encrypted using PKI encryption techniques to ensure the secrecy of the data, which cannot be viewed by unauthorized persons until the time of bid opening.
- 4.7 The uploaded documents become readable only after the tender opening by the authorized bid openers.
- 4.8 Upon the successful and timely submission of bids, the portal will give a successful bid submission message & a bid summary will be displayed with the bid no. and the date & time of submission of the bid with all other relevant details.
- 4.9 Please have all relevant documents in a single PDF file of compliance sheet.

5. AMENDMENT OF BID DOCUMENT:

- 5.1 At any time prior to the deadline for submission of bids, the Tender Inviting Authority reserve the right to add/modify/delete any portion of the Tender document by the issuance of a Corrigendum, which would be published on the website. The Corrigendum shall be binding on all bidders and will form part of the bid documents.

6. ASSISTANCE TO BIDDERS:

- 6.1 Any queries relating to the tender document and the terms and conditions contained therein should be addressed to the Tender Inviting Authority.
Contact person of the Tender Inviting Authority:
Shri Mallikarjuna Angadi, Librarian (Phone 0824 – 2473061 / 4062) e-Mail: mallikarjun@nitk.edu.in
- 6.2 Any queries relating to the process of online bid submission or queries relating to e-Wizard Portal, in general, may be directed to the 24x7 e-Wizard Helpdesk.
The contact number for the helpdesk is 011-49606060, 23710092, 23710091, helpdeskeuniwizarde@gmail.com
Mobile: +91-8448288987/88/89, e-Mail: eprochelpdesk.01@gmail.com

7. INSTRUCTIONS IN GENERAL:

- 7.1 **Process for Bid submission through MHRD portal is explained in Bidder Manual. Bidders are requested to download Bidder Manual from the home page of MHRD website (<https://mhrd.euniwizarde.com>). Steps are as follows: Home page Downloads Bidder Manuals.** ⇒ ⇒
- 7.2 The tenders will be received online through portal <https://mhrd.euniwizarde.com>. In the Technical Bids, the bidders are required to upload all the documents in **.pdf format**. Bidders are advised to follow the instructions provided in the 'Instructions to the Tenderers for the e-Submission of the bids online through the e-Wizard Portal for e-Procurement at <https://mhrd.euniwizarde.com>.

INTEGRITY PACT

To:

..... (Name & address of the agency)

.....

.....

Sub: Notice Inviting e-Tenders No. 08 / NITK / e-Library /FURN / OH-35 / 2020-21 / B4 dated 29-06- 2020
for the work of “**Manufacturing, Supply and installation furniture to e-Library Complex in NITK,
Surathkal**”

Sir,

It is hereby declared that NITK, Surathkal is committed to follow the principles of transparency, equity and competitiveness in public procurement.

The subject Notice Inviting Tender (NIT) is an invitation to offer made on the condition that the bidder will sign the Integrity Agreement, which is an integral part of tender/bid document, failing which the tenderer/ bidder will stand disqualified from the tendering process and the bid of the bidder would be summarily rejected.

This declaration shall form part and parcel of the Integrity Agreement and signing of the same shall be deemed as acceptance and signing of the Integrity Agreement on behalf of the NITK, Surathkal.

Yours sincerely

Registrar,
NITK, Surathkal.

From: (Name & address of the agency)

.....
.....

To: **Registrar,
NITK, Surathkal,
Srinivasnagar Post,
Mangaluru – 575025.**

Sub: Submission of Tender for the work of “**Manufacturing, Supply and installation furniture to e-Library Complex in NITK, Surathkal**”

Sir,

I/We acknowledge that NITK, Surathkal is committed to follow the principles thereof as enumerated in the Integrity Agreement enclosed with the tender/bid document.

I/We agree that the Notice Inviting Tender (NIT) is an invitation to offer made on the condition that I/We will sign the enclosed integrity Agreement, which is an integral part of the tender document, failing which I/We will stand disqualified from the tendering process. I/We acknowledge that THE MAKING OF THE BID SHALL BE REGARDED AS AN UNCONDITIONAL AND ABSOLUTE ACCEPTANCE of this condition of the NIT.

I/We confirm acceptance and compliance with the Integrity in letter and spirit and further agree that execution of the said Integrity Agreement shall be separated and distinct from the main contract, which will come into existence when tender/bid is finally accepted by NITK, Surathkal. I/We acknowledge and accept the duration of the Integrity Agreement, which shall be in the line with Article 1 of the enclosed Integrity Agreement.

I/We acknowledge that in the event of my / our failure to sign and accept the Integrity Agreement, while submitting the tender/bid, NITK, Surathkal shall have absolute and unfettered right to disqualify the tenderer/bidder and reject the tender/bid in accordance with terms and conditions of the tender/bid.

Yours faithfully,

Date:

(Duly authorized signatory of the Bidder)
Seal and signature of the contractor.

(To be signed by the bidder and same signatory competent / authorized to sign the relevant contract on behalf of NITK, Surathkal).

INTEGRITY PACT AGREEMENT

This Integrity Agreement is made at Surathkal on this day of 20

BETWEEN

National Institute of Technology Karnataka, Surathkal, an Institute of National Importance (under NIT Act -2007) represented through the Registrar, NITK, Surathkal (hereinafter referred as the '**Principal/Owner**', which expression shall unless repugnant to the meaning or context hereof include its successors and permitted assigns)

AND

.....
(Name and Address of the Individual/firm/Company)

Through (Hereinafter referred to as the "Bidder/Contractor" and which expression shall unless repugnant to the meaning or context hereof include its succession and permitted assigns)

Preamble

WHEREAS THE Principal / Owner has floated the Tender (Notice Inviting e-Tenders No.08 / NITK / e-Library /FURN / OH-35 / 2020-21 / B4 (Hereinafter referred to as "Tender/Bid") and intends to award, under laid down organizational procedure, contract for "**Manufacturing, Supply and installation furniture to e-Library Complex in NITK, Surathkal**" [Hereinafter referred to as the "**Contract**"].

AND WHEREAS the Principal/Owner values full compliance with all relevant laws of the land, rules, regulations, economic use of resources and of fairness/transparency in its relation with its Bidder(s) and Contractor(s).

AND WHEREAS to meet the purpose aforesaid both the parties have agreed to enter into this Integrity Agreement (hereinafter referred to as "**Integrity Pact**" or "**Pact**", the terms and conditions of which shall also be read as integral part and parcel of the Tender/Bid documents and Contract between the parties.

NOW, THEREFORE, in consideration of mutual covenants contained in this Pact, the parties hereby agree as follows and this witnesses as under:

Article 1: Commitment of the Principal/Owner

- i. The Principal /Owner commits itself to take all measures necessary to prevent corruption and to observe the following principles:
 - (a) No employee of the Principal /Owner, personally or through any of his/her family members, will in connection with the Tender, or the execution of the Contract, demand, take a promise for or accept, for self or third person, any material or immaterial benefit which the person is not legally entitled to.
 - (b) The Principal /Owner will, during the Tender process, treat all Bidder(s) with equity and reason. The Principal /Owner will, in particular, before and during the Tender process, provide to all Bidder(s) the same information and will not provide to any Bidder(s) confidential / additional information through which the Bidder(s) could obtain an advantage in relation to the Tender process or the Contract execution.
 - (c) The Principal /Owner shall endeavour to exclude from the Tender process any person, whose conduct in the past has been of biased nature.

- ii. If the Principal /Owner obtains information on the conduct of any of its employee which is a criminal offence under the Indian Penal code (IPC)/Prevention of Corruption Act, 1988 (PC Act) or is in violation of the principles herein mentioned or if there be a substantive suspicion in this regard, the Principal /Owner will inform the Chief Vigilance Officer and in addition can also initiate disciplinary actions as per its internal laid down policies and procedures.

Article 2: Commitment of the Bidder(s)/ Contractor(s)

- 1) It is required that each Bidder/Contractor (including their respective officers, employees and agents) adheres to the highest ethical standards, and report to the Government / Department all suspected acts of **fraud or corruption or Coercion or Collusion** of which it has knowledge or becomes aware, during the tendering process and through the negotiation or award of a contract.

- 2) The Bidders(s)/Contractor(s) commit himself to take measures necessary to prevent corruption. He commits himself to observe the following principles during his participation in the Tender process and during the Contract execution:

The Bidders(s)/Contractor(s) will not, directly or through any other person or firm, offer, promise or give to any of the Principal/Owner's employees involved in the Tender process or execution of the Contract or to any third person any material or other benefit which he/she is not legally entitled to, in order to obtain in exchange any advantage of any kind whatsoever during the Tender process or during the execution of the Contractor.

The Bidders(s)/Contractor(s) will not enter with other Bidders(s) into any undisclosed agreement or understanding, whether formal or informal. This applies in particular to prices, specifications, certifications, subsidiary contracts, submission or non-submission of bids or any other actions to restrict competitiveness or to cartelize in the bidding process.

The Bidders(s)/Contractor(s) will not commit any offence under the relevant IPC/PC Act. Further the Bidders(s)/Contractor(s) will not use improperly, (for the purpose of competition or personal gain), or pass on to others, any information or documents provided by the Principal/Owner as part of the business relationship, regarding plans, technical proposals and business details, including information contained or transmitted electronically.

The Bidders(s)/Contractor(s) of foreign origin shall disclose the names and address of agents/representatives in India, if any. Similarly Bidder(s)/Contractor(s) of Indian Nationality shall disclose names and address of foreign agents/representatives, if any. Either the Indian agent on behalf of the foreign principals or the foreign principal directly could bid in a tender but not both. Further, in cases where an agent participates in a tender on behalf of one manufacturer, he shall not be allowed to quote on behalf of another manufacturer along with the first manufacturer in a subsequent/parallel tender for the same item.

The Bidders(s)/Contractor(s) will, when presenting his bid, disclose (~~with each tender as per proforma enclosed~~) any and all payments he has made, is committed to or intends to make to agents, brokers or any other intermediaries in connection with the award of the Contract.

- iii. The Bidders(s)/Contractor(s) will not, instigate third persons to commit offences outlined above or be an accessory to such offences.

- iv. The Bidders(s)/Contractor(s) will not, directly or through any other person or firm indulge in fraudulent practice **means a wilful misrepresentation or omission of facts or submission of fake/forged documents in order to induce public official to act in reliance thereof, with the purpose of obtaining unjust advantage by or causing damage to justified interest of others and/or to influence the procurement process to the detriment of the Government interests.**

- v. The Bidders(s)/Contractor(s) will not, directly or through any other person or firm use Coercive practices (means the act of obtaining something, compelling an action or influencing a decision through intimidation, there or the use of force directly or indirectly, where potential or actual injury may befall upon a person, his/her reputation or property to influence their participation in the tendering process).

Article 3: Consequences of Breach

Without prejudice to any rights that may be available to the Principal/Owner under law or the Contract or its established policies and laid down procedures, the Principal/Owner shall have the following rights in case of breach of this Integrity Pact by the Bidders(s)/Contractor(s) and the Bidders/Contractor accepts and undertakes to respect and uphold the Principal/Owner's absolute right:

- 1) If the Bidders(s)/Contractor(s), either before awarded or during execution of Contract has committed a transgression through a violation of Article 2 above or in any other form, such as to put his reliability or credibility in question, the Principal/Owner after giving 14 days' notice to the contractor shall have powers to disqualify the Bidders(s)/Contractor(s) from the Tender process or terminate/determinate the Contract - if already executed, or exclude the Bidders/Contractor from future contract award processes. The imposition and duration of the exclusion will be determined by the severity of transgression and determined by the Principal/Owner. **Such exclusion may be forever or for a limited period as decided by the Principal/Owner.**
- 2) **Forfeiture of EMD/Performance Guarantee/Security Deposit:** If the Principal/Owner has disqualified the Bidders(s) from the tender process prior to the award of the Contract or terminate/determinate the Contract or has accrued the right to terminate/determinate the Contract according to Article 3(1), the Principal/Owner apart from exercising any legal rights that may have accrued to the Principal/Owner, may in its considered opinion forfeit the entire amount of Earnest Money Deposit, Performance Guarantee and Security Deposit of the Bidders/Contractor.
- 3) **Criminal Liability:** If the Principal/Owner obtains knowledge of conduct of a Bidder or Contractor, or of an employee or a representative or an associate of a Bidder or Contractor which constitutes corruption within the meaning of Indian Penal code (IPC)/Prevention of Corruption Act, or if the Principal/Owner has substantive suspicion in this regard, the Principal/Owner will inform the same to law enforcing agencies for further investigation.

Article 4: Previous Transgression

- 1) The Bidder declares that no previous transgressions occurred in the last 5 years with any other Company in any country conforming to the anticorruption approach or with Central Government or State Government or any other Central/State Public Enterprises in India that could justify his exclusion from the Tender process.
- 2) If the Bidder makes an incorrect statement on this subject, he can be disqualified from the Tender process or action can be taken for banning of business dealings/ holiday listing of the Bidder/Contractor as deemed fit by the Principal/Owner.
- 3) If the Bidder/Contractor can prove that he has resorted/recouped the damage caused by him and has installed a suitable corruption prevention system, the Principal/Owner may, at its own discretion, revoke the exclusion prematurely.

Article: 5 Equal Treatment of all Bidder/Contractors

- 1) The Bidders(s)/Contractor(s) undertake(s) to demand from all subcontractors a commitment in conformity with this Integrity Pact. The Bidders/Contractor shall be responsible for any violation(s) of the principles laid down in this agreement/Pact by any of its Sub-contractors/sub-vendors.
- 2) The Principal/Owner will enter into pacts on identical terms as this one with all Bidders and Contractors.

- 3) The Principal/Owner will disqualify Bidders, who do not submit, the duly signed pact between the Principal/Owner and the bidder, along with the Tender or violate its provisions at any stage of the Tender process, from the Tender process.

Article 6: Duration of the Pact

This Pact begins when both the parties have legally signed it. It expires for the Contractor/Vendor 12 months after the completion of work under the contract or till the continuation of defect liability period, whichever is more - and for all other bidders, till the Contract has been awarded.

If any claim is made/lodged during the time, the same shall be binding and continue to be valid despite the lapse of this pacts as specified above, under it is discharged/determined by the Competent Authority of NITK, Surathkal.

Article 7: Other Provisions

- 1) This Pact is subject to Indian Law, place of performance and jurisdiction is **Mangaluru**, the Headquarters of the Principal/Owner, who has floated the Tender.
- 2) Changes and supplements need to be made in writing. Side agreements have not been made.
- 3) If the Contractor is a partnership or a consortium, this Pact must be signed by all the partners or by one or more partner holding power of attorney signed by all partners and consortium members. In case of a Company, the Pact must be signed by a representative duly authorized by board resolution.
- 4) Should one or several provisions of this Pact turn out to be invalid; the remainder of this Pact remains valid. In this case, the parties will strive to come to an agreement to their original intentions.
- 5) It is agreed term and condition that any dispute or difference arising between the parties with regard to the terms of this Integrity Agreement / Pact, any action taken by the Owner/Principal in accordance with this **Integrity Agreement / Pact or interpretation thereof shall not be subject to arbitration.**

Article 8: LEGAL AND PRIOR RIGHTS

All rights and remedies of the parties hereto shall be in addition to all the other legal rights and remedies belonging to such parties under the Contract/ or law and the same shall be deemed to be cumulative and not alternative to such legal rights and remedies aforesaid. For the sake of brevity, both the Parties agree that this Integrity Pact will have precedence over the Tender/Contract documents with regard any of the provisions covered under this Integrity Pact.

IN WITNESS WHEREOF the parties have signed and executed this Integrity Pact at the place and date first above mentioned in the presence of following witnesses:

.....
(For and on behalf of Principal/Owner)

.....
(For and on behalf of bidder/ contractor)

WITNESSES:

1.
(Signature, name and address)

2.
(Signature, name and address)

Place: Surathkal.

Date:

Checklist – Documents to be kept ready for uploading after scanning (.pdf)

The bidder shall verify his tender properly before its submission in e-procurement portal and satisfy that all the information is submitted. The following documents (Certified or self-attested) be kept ready duly scanned (.pdf) for uploading while submission of e-tenders.

Sl. No.	Requirement	Document to be scanned and submitted by uploading
Check list for documents required under Eligibility criteria		
1	The bidder must be a registered contractor of Karnataka PWD/ Central PWD/ Dept. of Electrical Inspectorate of appropriate class mentioned in Notice inviting e-Tenders	Registration certificate
2	The bidder must possess valid GST registration	GST registration
3	The bidder must possess valid PAN registration with Income Tax department	PAN card
4	The bidder must be registered under Employees Provident Fund (EPF) Act- (if not applicable as per the said Act-enclose exemption declaration duly signed and stamped).	EPF registration
5	The bidder must be registered under Employees State Insurance (ESI) Act-(if not applicable as per the said Act-enclose exemption declaration duly signed and stamped).	ESI registration
6	The agency must have the experience of having successfully completed similar work as follows during the past seven financial years as insisted in the Notice inviting e-tenders, as follows: (i)At least three single similar works, each work costing not less than ₹ 9.86 Lakh OR (ii)Two similar works, each work costing not less than ₹ 14.80 Lakh; OR (iii)One similar work of not less than ₹ 19.73 Lakh. Note: Exemptions to MSMEs/Startups as per GOI norms.	Work experience certificate issued by the Client (Supported by TDS if the certificate is from Private firm).
7.	Warranty period 5 Years	
8.	In – house manufacturing and testing facility should be available.	
Other general documents to consider their bid for evaluation of technical bid		
1	Proof of Payment towards EMD	e-payment or MSME/ NSIC certificate in case of MSME/ NSIC registered bidders if seeking exemption of EMD
2	Bank details of the bidder for making payment through RTGS	May be typed as per the format given, scanned and uploaded
3	Tender document	Tender document may be downloaded, signed and uploaded.

NATIONAL INSTITUTE OF TECHNOLOGY KARNATAKA, SURATHKAL

POST SRINIVASNAGAR, MANGALORE – 575 025

GENERAL INSTRUCTIONS

1. An agreement shall be drawn with the successful bidder on prescribed Form.
2. The time allowed for carrying out the work will be from the first day of handing over of the site or from the fifteenth day from the date of issue of work order, whichever is early, in accordance with the phasing, if any, indicated in the tender documents.
3. The site for the work is available.

OR

~~The site for the work shall be made available in parts as specified below:-~~

.....

.....
4. Tender documents consisting of plans, specifications, the schedule of quantities of the various classes of work to be done and the set of terms & conditions of contract to be complied with by the bidder whose tender may be accepted and other necessary documents can be seen in the office of the Director/ Registrar, NITK, Surathkal (Building and Works section/ Office of the Resident Engineer) between hours of 9:00 & 17:00 every day except on Saturdays, Sundays and Public Holidays.
5. The bidder whose tender is accepted shall submit an irrevocable PERFORMANCE GUARANTEE of 5% (Five percent) of the tendered amount in addition to other deposits mentioned elsewhere in the contract for his proper performance of the contract agreement, (not withstanding and/or without prejudice to any other provisions in the contract) within 7 days of issue of letter of intent. In case the bidder fails to deposit the said performance guarantee, the earnest money deposited by the bidder shall be forfeited in full automatically without any notice to the bidder.
6. **All applicable taxes which are to be deducted at source (TDS), income tax, labour cess etc** as per the orders of the Government (State and/ or Central) in force from time to time shall be deducted at source and TDS certificate shall be issued. The contractors quoted rate should be inclusive of all taxes (**Except only GST, which has to be quoted separately**), cess and levies on material and labour and no extra claim whatsoever in this connection shall be entertained. **The contractors quoted rate should also be inclusive of EPF and ESI benefits to be given to the employees/ workers engaged by him as per the statutory requirements. GST – as applicable should be quoted separately [GST amount on Price quoted].**
7. The competent authority on behalf of the Institute (NITK) does not bind himself to accept the lowest or any other tender and reserves to himself the authority to reject any or all the tenders received without the assignment of any reason. All tenders in which any of the prescribed condition is not fulfilled or any condition including that of conditional rebate is put forth by the tenderer shall be summarily rejected.
8. Canvassing whether directly or indirectly, in connection with tenders is strictly prohibited and the tenders submitted by the contractors who resort to canvassing will be liable to rejection.
9. The competent authority on behalf of the Institute (NITK) reserves to himself the right of accepting the whole or any part of the tender and the tenderer shall be bound to perform the same at the rate quoted.
10. **The tender for the works shall remain open for acceptance for a period of 90 (ninety) days from the date of last day for submission of tenders.** If any tenderer withdraws his tender before the said period or makes any modifications in the terms and conditions of the tender which are not acceptable to the Institute, then the Institute shall, without prejudice to any other right or remedy, be at liberty to forfeit the said earnest money as aforesaid in full. Further, the tenderer shall not be allowed to participate in the re-tendering of the work.
11. The Notice Inviting Tender shall form a part of the contract document. The successful tenderer/contractor, on acceptance of his tender by the Accepting Authority, shall, within 7 days from the issue of Letter of Intent, sign the contract consisting of:-

- a) The notice inviting e-tenders, all the documents including terms and conditions, additional conditions, specifications and drawings if any forming the tender as issued at the time of invitation of tender and acceptance thereof together with any correspondence leading thereto.

- b) Special terms and conditions.

T E N D E R

I/We have read and examined the notice inviting e-tender, Specifications applicable, Drawings & Designs, General Rules and Directions, Conditions of Contract, clauses of contract, Special conditions, Schedule of Rate & other documents and Rules referred to in the conditions of contract and all other contents in the tender document for the work.

I/We hereby tender for the execution of the work specified for the National Institute of Technology Karnataka, Surathkal within the time specified, schedule of quantities and in accordance in all respects with the specifications, designs, drawings and instructions in writing referred.

We agree to keep the tender open for **ninety (90) days** from the due date of submission thereof and not to make any modifications in its terms and conditions.

A sum of ₹ 49,334/- is hereby forwarded through RTGS as earnest money. If I/we, fail to commence the work specified I/we agree that the Director, NITK, Surathkal / Registrar, NITK, Surathkal or his successors in office shall without prejudice to any other right or remedy, be at liberty to forfeit the said earnest money absolutely otherwise the said earnest money shall be retained by the Institute towards security deposit to execute all the works referred to in the tender documents upon the terms and conditions contained or referred to therein and to carry out such deviations as may be ordered.

I/We further agree that in case of forfeiture of earnest money or both Earnest Money & Performance Guarantee as aforesaid, I/We shall be debarred for participation in the re-tendering process of the work.

I/We hereby declare that I/we shall treat the tender documents drawings and other records connected with the work as secret/confidential documents and shall not communicate information/derived therefrom to any person other than a person to whom I/we am/are authorized to communicate the same or use the information in any manner prejudicial to the safety of the State.

I/ We hereby declare that I/ We shall comply with the provisions of the Payment of Wages Act, 1936; Minimum Wages Act, 1948; Employees Liability Act, 1938; Workmen's Compensation Act, 1923; Industrial Disputes Act, 1947; Maternity Benefits Act, 1961; and the Contractor's Labour (Regulation and Abolition) Act 1970 and the Central Rules framed thereunder; Building and other Construction Workers' (Regulation of Employment and Conditions of Service) Act, 1996; Building **and other Construction Workers Welfare Cess Act, 1996**, ESI Act, EPF Act and the modifications thereof or any other laws relating thereto and the rules made thereunder from time to time. **I/We further declare that my/ our quoted rates are inclusive of all my/ our obligations under the said Acts and further understand that these Acts are deemed to be a part of the contract agreement.**

I / We declare that the Specifications, Plans, Drawings, Design and conditions of the contract on which the rates have been based, have been completely studied by me/us before submitting this tender.

I / We declare that I/we have inspected the work spot and have made myself/ourselves thoroughly conversant and satisfied as regards the materials and labour; and particulars of various leads with which the materials are to be brought to the work site.

I/We declare that the rates quoted by me/us are inclusive of all taxes and cess on materials and labours, royalties, water and electricity arrangement required for the work, all lead and lifts, loading and unloading, benevolent fund etc. and as such I/we have no any claims for higher rates over our quoted rates.

I / We declare that we have understood all the conditions mentioned in the tender, and also the specifications stipulated in the tender by going through myself/ ourselves or by getting translated into my / our own mother tongue.

I/We agree that should I/we fail to commence the work specified in the above memorandum, an amount equal to the amount of the earnest money mentioned in the form of invitation of tender and performance guarantee shall be absolutely forfeited to the National Institute of Technology, Surathkal and the same may at the option of the competent authority on behalf of the National Institute of Technology Karnataka, Surathkal be recovered without prejudice to any other right or remedy available in law out of the deposit in so far as the same may extend in terms of the said bond and in the event of deficiency out of any other money due to me/us under this contract or otherwise.

Dated

Signature of Contractor
Postal Address

Witness:
Address:
Occupation:

ACCEPTANCE

The above tender (as modified by you as provided in the letters mentioned hereunder) is accepted by me for and on behalf of National Institute of Technology Karnataka, Surathkal for a sum of ₹-----)
(Rupees

The letters referred to below shall form part of this contract Agreement: -

- a) Letter of Intent dated
- b) all future correspondences between the parties
- c)

Registrar
For & on behalf of NITK, Surathkal

Dated.....

GENERAL INSTRUCTIONS, TERMS & CONDITIONS AND CLUSES OF CONTRACT

General Instructions, terms and conditions:

- 1) Canvassing or offer of an advantage or any other inducement by any person with a view to influencing acceptance of a bid will be an offence under Laws of India. Such action will result in outright rejection of the bid, in addition to other punitive measures.
- 2) Where the context so requires, words imparting the singular only also include the plural and vice versa. Any reference to masculine gender shall whenever required include feminine gender and vice versa.
- 3) The rate quoted shall satisfy all terms and conditions of the tender document including all statutory obligations of the bidder. **All applicable taxes which are to be deducted at source such as income tax, labour cess, Portion of GST etc.** as per the orders of the Government (State and/ or Central) in force from time to time shall be deducted at source and TDS certificate shall be issued. Any tax omitted for deduction shall be deducted from the subsequent bills/security deposits. The bidder's quoted rate should be inclusive of all taxes, cess and levies on material and labour and **no extra claim whatsoever in this connection shall be entertained**. The bidder's quoted rate should also be inclusive of EPF and ESI benefits to be given to the employees/ workers engaged by him as per the statutory requirements.
- 4) The bidder shall comply with the provisions of the Apprentices Act 1961, and the rules and orders issued thereunder from time to time. If he fails to do so, his failure will be a breach of the contract and the Institute may in its discretion, without prejudice to any other right or remedy available in law, cancel the contract. The bidder shall also be liable for any pecuniary liability arising on account of any violation by him of the provisions of the said Act.
- 5) The contractor shall ensure full compliance with tax laws of India with regard to this contract and shall be solely responsible for the same. The contractor shall submit copies of acknowledgements evidencing filing of returns and shall keep the Institute fully indemnified against liability of tax, interest, penalty etc of the contractor in respect thereof, which may arise. The Institute in no way shall be responsible / held responsible for the statutory compliances of the Contractor. In case the Institute is required, by the order of the Law, to fulfill the obligations of the Contractor, the same shall be recovered from the contractor out of his bills or deposits.
- 6) The bid shall be valid for **90 days** from the date of its submission for acceptance. Withdrawal of a tender after its submission is not permitted. If a bidder withdraws his tender after its submission, then the EMD is liable for forfeiture in full.
- 7) EMD of the successful bidder shall be retained till the successful completion of the contract (including defects liability period). EMD shall bear no interest.
- 8) Forfeiture of EMD and SD: The EMD and SD shall be forfeited in case of any breach of terms and conditions of the contract.
- 9) RELEASE OF EMD and SD: The EMD and SD of the successful tenderer shall be returned without any interest on completion of the defects liability period after adjusting any dues from him on the recommendations of the Engineer in charge of the Institute [& NOC from the ALC (C), as applicable].
- 10) E.M.D of the unsuccessful bidder will be refunded without any interest within 90 days from the date of submission of the tenders. The E.M.D. shall be forfeited if a bidder withdraws his bid during the period of validity specified.
- 11) The bid of any bidder who does not accept the conditions contained in the tender document is liable to be rejected.
- 12) Bidders are advised to inspect and examine the site and its surroundings and satisfy themselves before submitting their bid as to the nature of the working site, the form and nature of the site, the means of access to the site, the accommodation they may require and in general shall themselves obtain all necessary information as to risks, contingencies and other circumstances which may influence or affect their tender. A bidder shall be deemed to have full knowledge of the site whether he inspects it or not and no extra charges consequent on any misunderstanding or otherwise shall be allowed. The bidder shall be responsible for **arranging and maintaining** at his own cost all

materials, tools & plants, water, **electricity access**, facilities for workers and all other services required for executing the work unless otherwise specifically provided for in the contract documents. Submission of a bid by a bidder implies that he has read this notice and all other contract documents and has made himself aware of the scope and specifications of the work to be done and local conditions and other factors having a bearing on the execution of the work.

- 13) In the case of any bid where unit rate of any item/items appears to be unrealistic, such bid will be considered as unbalanced and in case the bidder is unable to provide satisfactory explanation, such a bid is liable to be disqualified and rejected.
- 14) The scope of work covered in this tender shall be as per the BOQ, specifications, drawings, instructions, orders issued to the contractor from time to time during the execution of work. **The quantity of various items as entered in the BOQ are indicative only and may vary depending upon the actual requirement. The contractor shall be bound to carry out and complete the stipulated work irrespective of the variation in individual items specified in the bill of quantities.**
- 15) The work to be carried out under the Contract shall, except as otherwise provided in these conditions, include all labour, materials, tools, plants, equipment and transport which may be required in preparation of and for and in the full and entire execution and completion of the works. The descriptions given in the Schedule of Quantities (Schedule-A) shall, unless otherwise stated, be held to include wastage on materials, carriage and cartage, carrying and return of empties, hoisting, setting, marking out, fitting and fixing in position and all other labours necessary and for the full and entire execution, and completion of the work as aforesaid in accordance with good practice and recognized principles.
- 16) The bidder shall be deemed to have satisfied himself before tendering as to the correctness and sufficiency of his tender for the works and of the rates and prices quoted in the Schedule of Quantities, which rates and prices shall, except as otherwise provided, cover all his obligations under the Contract and all matters and things necessary for the proper completion and maintenance of the works during defects liability.
- 17) The several documents forming the contract are to be taken as mutually explanatory of one another, detailed drawings being followed in preference to small scale drawing and figured dimensions in preference to scale and special conditions in preference to General Conditions.
- 18) If there are varying or conflicting provisions made in any one document forming part of the contract, the Accepting Authority shall be the deciding authority with regard to the intention of the document and his decision shall be final and binding on the contractor.
- 19) Rate for all items shall be quoted on the tender form (in e-procurement portal).
- 20) **Zero Deviation Bid from the Technical Specification: Bidders are instructed to quote strictly as per technical specification in the bid document as this is a zero-deviation bid, failing which the bid will be treated as non – responsive and will be summarily rejected.**
- 21) The bidder shall agree under the Officials Secret Act, 1923, for maintaining the secrecy of the bid document drawings or other records connected with the work given to them.
- 22) The rate quoted by the bidder **shall be firm throughout the contract** period and there shall be no revision of the rates for any reasons whatsoever. It should be clearly understood that any claim for changes will not be entertained in any case once the bids are opened.
- 23) Any error in description, quantity or rate in Schedule of Quantities or any omission therefrom shall not vitiate the Contract or release the Contractor from the execution of the whole or any part of the works comprised therein according to drawings and specifications or from any of his obligations under the contract
- 24) The acceptance of bid shall rest with the Institute. The Institute is not bound to accept the lowest bid and reserves the authority to reject any or all the bids.
- 25) The Institute reserves the right of accepting whole or any part of the bid and the bidder shall be bound to perform the same at the quoted rates.

- 26) One bid per bidder: Each bidder shall submit only one bid either by himself or by representing a firm.
- 27) Cost of bid: The bidder shall bear all costs associated with the preparation and submission of his bid. The Institute in no case shall be responsible or liable for those costs.
- 28) The bidder shall not make or cause to be made any alteration, erasure or obliteration to the text of the tender document.
- 29) In case the bidder has any doubt about the meaning of anything contained in the tender document, he shall seek clarification from the Institute before 11:00 hours on 18-07-2020 in writing. All such clarifications, together with all details on which the clarification had been sought will be uploaded to the NITK website/ e-tender platform. Such clarifications shall form part of the tender document.
- 30) Bid and all accompanying documents shall be in English. In case any accompanying documents are in other languages, it shall be accompanied by an English translation. The English translation shall prevail in matters of interpretation.
- 31) The bidder shall quote his rate in Indian rupees.
- 32) Conditional bids/ offers shall summarily be rejected.
- 33) A bidder signing the bid document must specify whether he signs as (applicable while signing the contract agreement):
- (i) A sole proprietor of the firm or constituted attorney of such proprietor;
 - (ii) A partner/ managing partner of a partnership firm. In this case, he must have a clear legal authority to sign for the firm.
 - (iii) Constituted attorney, if for a Company.

If an individual makes the tender, it shall be signed with his full name and his complete address shall be given. If it is made by partnership firm, it shall be signed by all the partners or the authorized signatory who shall sign his own name and give the name and address of each partner of the firm and attach a copy of 'Power of Attorney' with the tender authorizing him to sign on behalf of the other partners. A certified copy of the 'Registered Partnership Deed' shall also be submitted along with the tender. In case the tender is made by or on behalf of a company incorporated under the Companies Act 1956, it shall be signed by the Managing Director or by one of the Directors duly authorized on this behalf and shall include a copy of the 'Power of Attorney' with the tender. A certified copy of the registered Deed shall also be submitted along with the tender.

- 34) The Institute will declare a bidder ineligible either indefinitely or for a specified period of time at the sole discretion of the Institute for the award of contract/ participating in the tenders if at any time the Institute determines that he has furnished false information/ engaged in corrupt or fraudulent practices.
- 35) **The price bid of bidders who have not qualified in the technical bid shall not be opened.**
- 36) The Contractor shall not sub-let the contract or any part thereof or any benefit or interest therein or thereunder.
- 37) The Institute will not provide residential accommodation to any of the workers of the contractor. The contractor shall have to make his own arrangement for the residential accommodation of workers outside the institute campus.
- 38) If any overpayment is detected as a result of post-payment audit, it shall be recovered by the Institute from the contractor out of his bills or deposits.
- 39) Subject to the Institute's right to accept any bid/ reject any or all the bids, the Institute will award the contract to the bidder whose bid has been determined to be substantially responsive, provided further that the bidder has the capability and resources to carry out similar type contracts effectively. Eligibility shall be based on the evaluation of the details furnished in the bid. Copies of the testimonials and other documentary evidences must be submitted (in e-

procurement portal) along with the Bid for evaluation and confirmation of qualifying requirements. Bids of those tenderers, who in the opinion of the Institute do not satisfy the above requirements, will not be considered.

40) Prior to the expiry of the period of validity of the bid, the Institute will notify the successful bidder in writing by registered/ speed post/ e-mail letter that his bid has been accepted. This letter (hereinafter referred as the Letter of Intent) shall name the sum, which the Institute will pay the bidder in consideration of the execution of the work by the bidder as specified in the contract document (hereinafter called as the contract price). This letter of Intent will form a part of the Contract.

41) On receipt of this letter of Intent, the successful bidder will have to enter into an agreement. If the bidder fails to execute the agreement within the specified time, the earnest money deposit shall be forfeited to the Institute and the bid will be rejected. If any loss to the Institute results as a result of such measures due to the default of the bidder, the same will be recovered from the bidder by suitable course of action including legal proceedings.

The cost of the non-judicial stamp-paper required for the agreement shall be borne by the contractor.

42) Determination of successful bidder: The bidder (technically qualified) who quotes evaluated **lowest total bid** shall be the successful bidder subject to its meeting to the statutory requirements.

43) Amendment of tender document: At any time prior to the last date of receipt of bids, Institute may for any reason, whether at its own initiative or in response to a clarification requested by prospective bidder, modify the Tender document by an amendment. The Institute may at its own discretion extend the last date for the receipt of bids.

44) The Hon'ble High Court at Bengaluru shall have the exclusive jurisdiction to try any disputes, if any, arising out of this contract between the parties.

Clauses of Contract:

Clause 1: Performance Guarantee:

- 1.1 The contractor shall submit an irrevocable PERFORMANCE GUARANTEE of 5% (Five percent) of the bid amount in addition to other deposits mentioned elsewhere in the contract for his proper performance of the contract agreement, (not withstanding and/or without prejudice to any other provisions in the contract) within 7 days of issue of letter of intent. This period can be further extended by Institute up to a maximum period of 7 days on written request of the contractor stating the reason for delays in procuring the Performance Guarantee, to the satisfaction of the Institute. This performance guarantee shall be in the form of Fixed Deposit Receipts or Guarantee Bonds of any Scheduled Bank or DD or NEFT/ RTGS transfer.
- 1.2 The Performance Guarantee shall be initially valid up to the stipulated date of completion plus 120 days beyond that. In case the time for completion of work gets enlarged, the contractor shall get the validity of Performance Guarantee extended to cover such enlarged time for completion of work. After recording of the completion certificate for the work by the competent authority, the performance guarantee shall be returned to the contractor, without any interest.
- 1.3 The Engineer-in-Charge shall not make a claim under the Performance Guarantee except for amounts to which the Institute is entitled under the contract (notwithstanding and/or without prejudice to any other provisions in the contract agreement) in the event of:
- a. Failure by the contractor to extend the validity of the Performance Guarantee as described herein above, in which event the Engineer-in-Charge may claim the full amount of the Performance Guarantee.
 - b. Failure by the contractor to pay Institute any amount due, either as agreed by the contractor or determined under any of the Clauses/Conditions of the agreement, within 30 days of the service of notice to this effect by Engineer-in-Charge.
- 1.4 In the event of the contract being determined or rescinded under provisions of any of the clause/condition of the contract, the performance guarantee shall stand forfeited in full and shall be absolutely at the disposal of the Institute.

Clause 2: Security Deposit

- 2.1 The bidder whose tender is accepted will also be required to furnish by way of Security Deposit for the fulfillment of his contract, an amount **equal to 2.5% of the bid value** of the work. The Security deposit will be collected by deductions from the running bills of the contractor at the rates mentioned above. The earnest money deposited at the time of bid will be treated as a separate part of the Security Deposit. The bidder whose tender(s) may be accepted (hereinafter called the contractor) shall permit the Institute at the time of making any payment to him for work done under the contract to deduct a sum at the rate of 2.5% of the gross amount of each running bill towards Security Deposit. This Security Deposit shall bear no interest.
- 2.2 All compensations or the other sums of money payable by the contractor under the terms of this contract may be deducted from, or paid by the sale of a sufficient part of his security deposit, or from any sums which may be due to or may become due to the contractor by the Institute on any account whatsoever and in the event of his Security Deposit being reduced by reason of any such deductions or sale as aforesaid, the contractor shall within 10 days make good in cash or DD or Fixed Deposit Receipt endorsed in favour of the Institute, any sum or sums which may have been deducted from, or raised by sale of his security deposit or any part thereof. The security deposit shall be collected from the running bills of the contractor at the rates mentioned above
- 2.3 The security deposit as deducted above can be released against bank guarantee issued by a scheduled bank, on its accumulations to a minimum of ` 5 lakh (Rupees Five lakh) subject to the condition that amount of such bank guarantee, except last one, shall not be less than ₹5 lakh. Provided further that the validity of bank guarantee including the one give against the earnest money shall be valid till the defects liability period.

Clause 3: Compensation for delay in the work:

- 3.1 If the contractor fails to maintain the required progress or to complete the work and clear the site on or before the contract or justified extended date of completion, he shall, without prejudice to any other right or remedy available under the law to the Institute on account of such breach, pay to the Institute as agreed compensation the amount

calculated at the rates stipulated below or such smaller amount as the Engineer in-charge (whose decision in writing shall be final and binding) may decide on the amount of bid value of the work for every completed day/month (as determined) that the progress remains below or that the work remains incomplete.

Compensation for delay of work @ 1% per month of delay to be computed on per day basis.

- 3.2 Provided always that the total amount of compensation for delay to be paid under this condition shall not exceed 10% of the Bid Value of work. The amount of compensation may be adjusted or set-off against any sum payable to the Contractor under this or any other contract with the Institute.
- 3.3 In case no compensation has been decided by the Engineer-in-charge during the progress of work, this shall be no waiver of right to levy compensation by the said authority if the work remains incomplete on final justified extended date of completion. If the Engineer- in -Charge decides to give further extension of time allowing performance of work beyond the justified extended date, the contractor shall be liable to pay compensation for such extended period.

Clause 4: Incentive for early completion:

In case, the contractor completes the work ahead of scheduled completion time, a bonus at 1% of the bid value per month computed on per day basis, shall be payable to the contractor, subject to a maximum limit of 5% (five percent) of the bid value. The amount of bonus, if payable, shall be paid along with final bill after completion of work.

Clause 5: When contract can be determined:

- 5.1 Subject to other provisions contained in this clause, the Institute may, without prejudice to its any other rights or remedy against the contractor in respect of any delay, inferior workmanship, any claims for damages and/or any other provisions of this contract or otherwise, and whether the date of completion has or has not elapsed, by notice in writing absolutely, determine the contract in any of the following cases:
- i) If the contractor having been given by the Engineer-in-Charge a notice in writing to rectify, reconstruct or replace any defective work or that the work is being performed in an inefficient or otherwise improper or unworkmanlike manner, shall omit to comply with the requirement of such notice for a period of seven days thereafter.
 - ii) If the contractor has, without reasonable cause, suspends the progress of the work or has failed to proceed with the work with due diligence so that in the opinion of the Engineer-in-Charge (which shall be final and binding) he will be unable to secure completion of the work by the date for completion and continues to do so even after a notice in writing of seven days from the Engineer-in-Charge.
 - iii) If the contractor fails to complete the work or section of work with individual date of completion on or before the stipulated or justified extended date, on or before such date of completion; and the Engineer in Charge (or the Institute) without any prejudice to any other right or remedy under any other provision in the contract has given further reasonable time in a notice given in writing in that behalf as either mutually agreed or in absence of such mutual agreement by his own assessment making such time essence of contract and in the opinion of Engineer-in-Charge the contractor will be unable to complete the same or does not complete the same within the period specified.
 - iv) If the contractor persistently neglects to carry out his obligations under the contract and/or commits default in complying with any of the terms and conditions of the contract and does not remedy it or does not take effective steps to remedy it within 7 days after a notice in writing is given to him in that behalf by the Engineer-in-Charge.
 - v) If the contractor shall offer or give or agree to give to any person in the Institute service or to any other person on his behalf any gift or consideration of any kind as an inducement or reward for doing or forbearing to do or for having done or forborne to do any act in relation to the obtaining or execution of this or any other contract for Institute.
 - vi) If the contractor obtains contract with the Institute as a result of wrong tendering or other non-bonafide methods of competitive tendering or commits breach of Integrity Agreement.

- vii) The contractor being an individual, or if a firm, any partner thereof shall any time be adjudged insolvent or have a receiving order or order for administration of his estate made against him or shall take any proceedings for liquidation or composition (other than a voluntary liquidation for the purpose of amalgamation or reconstruction) under any Insolvency Act for the time being in force or make any conveyance or assignment of his effects or composition or arrangement for the benefit of his creditors or purport so to do, or if any application be made under any Insolvency Act for the time being in force for the sequestration of his estate or if a trust deed be executed by him for benefit of his creditors.
- viii) If the contractor being a company shall pass a resolution or the court shall make an order that the company shall be wound up or if a receiver or a manager on behalf of a creditor shall be appointed or if circumstances shall arise which entitle the court or the creditor to appoint a receiver or a manager or which entitle the court to make a winding up order.
- ix) If the contractor shall suffer an execution being levied on his goods and allow it to be continued for a period of 21 days.
- x) If the contractor assigns, transfers, sublets (engagement of labour on a piece-work basis or of labour with materials not to be incorporated in the work, shall not be deemed to be subletting) or otherwise parts with or attempts to assign, transfer, sublet or otherwise parts with the entire works or nay portion thereof without the prior written approval of the Engineer-in-Charge.
- xi) If the work is not started by the contractor within 1/8th of the stipulated time.

When the contractor has made himself liable for action under any of the cases aforesaid, the Institute shall have powers:

- a) To determine or rescind the contract as aforesaid (of which termination or rescission notice in writing to the contractor shall be conclusive evidence). Upon such determination or rescission, the Earnest money deposit, Security Deposit already recovered and Performance Guarantee under the contract shall be liable to be forfeited in full and shall be absolutely at the disposal of the Institute.
- b) After giving notice to the contractor to measure up the work of the contractor and to take such whole, or the balance or part thereof, as shall be un-executed out of his hands and to give it to another contract to complete the work. The contractor, whose contract is determined as above, shall not be allowed to participate in the tendering process for the balance work.

In the event of above course (s) being adopted by the Institute, the contractor shall have no claim to compensation for any loss sustained by him by reason of his having purchased or procured any materials or entered into any engagements or made any advances on account or with a view to the execution of the work or the performance of the contract. And in case action is taken under any of the provision aforesaid the contractor shall not be entitled to recover or be paid any sum for any work thereof or actually performed under this contract unless and until the Engineer-in-Charge has certified in writing the performance of such work and the value payable in respect thereof and he shall only be entitled to be paid the value so certified.

5.2 In case the work cannot be started due to the reason not within the control of the contractor within 1/8th of the stipulated time for completion of work or one month – whichever is more, either party may close the contract by giving notice to other party stating reasons. In such eventuality, the Earnest Money Deposit and the performance Guarantee of the contractor shall be refunded, but no payment on account of Interest, loss of profit or damages etc shall be payable at all.

5.3 In any case in which any of the powers conferred upon the Engineer-in-Charge by Clause-5.1 thereof, shall have become exercisable and the same are not exercised, the non-exercise thereof shall not constitute a waiver of any of the conditions hereof and such powers shall notwithstanding be exercisable in the event of any future case of default by the contractor and the liability of the contractor for compensation shall remain unaffected. In the event of the Engineer-in-Charge putting in force all or any of the powers vested in him under the preceding clause he may, if he so desires after giving a notice in writing to the contractor, take possession of (or at the sole discretion of the Engineer-in-Charge which shall be final and binding on the contractor) use as on hire (the amount of the hire money being also in the final determination of the Engineer-in-Charge) all or any tools, plant, materials and stores, in or upon the works, or the site thereof belonging to the contractor, or procured by the contractor and intended to be used for the execution of

the work/or any part thereof, paying or allowing for the same in account at the contract rates, or, in the case of these not being applicable, at current market rates to be certified by the Engineer-in-Charge, whose certificate thereof shall be final, and binding on the contractor, clerk of the works, foreman or other authorized agent to remove such tools, plant, materials, or stores from the premises (within a time to be specified in such notice) and in the event of the contractor failing to comply with any such requisition, the Engineer-in-Charge may remove them at the contractor's expense or sell them by auction or private sale on account of the contractor and his risk in all respects and the certificate of the Engineer-in-Charge as to the expenses of any such removal and the amount of the proceeds and expenses of any such sale shall be final and conclusive against the contractor.

Clause 6: Time and extension for delay:

The time allowed for execution of the Work, or the extended time in accordance with these conditions shall be the essence of the Contract. The execution of the work shall commence from the 15th Day or such time period as mentioned in letter of Award/ Letter of Intent/ Work order or from the date of handing over the site whichever is later. If the Contractor commits default in commencing the execution of the work as aforesaid, Institute shall without prejudice to any other right or remedy available in law, be at liberty to forfeit the earnest money and performance guarantee absolutely.

As soon as possible after the Contract is concluded, the Contractor shall submit a Time and Progress Chart and get it approved by the Engineer in-charge.

If the work(s) is delayed by: -

- i) force majeure, or
- ii) abnormally bad weather, or
- iii) serious loss or damage by fire, or
- iv) civil commotion, local commotion of workmen, strike or lockout, affecting any of the trades employed on the work, or
- v) delay on the part of other contractors or tradesmen engaged by Engineer-in-Charge in executing work not forming part of the Contract, or
- vi) Any other cause which, in the absolute discretion of the Engineer in-charge, is beyond the Contractor's control.

then upon the happening of any such event causing delay, the Contractor shall immediately give notice thereof in writing to the Engineer-in-Charge but shall nevertheless use constantly his best endeavors to prevent or make good the delay and shall do all that may be reasonably required to the satisfaction of the Engineer-in-Charge to proceed with the works.

Request for re-scheduling the milestones and extension of time, to be eligible for consideration, shall be made by the Contractor in writing within seven days of the happening of the event causing delay. The Contractor may also, if practicable, indicate in such a request the period for which extension is desired.

In any such case, the Institute may give a fair and reasonable extension of time and re-schedule milestones for completion of work. Such extension shall be communicated to the Contractor by the Institute in writing, within 3 months of the date of receipt of such request. Non-application by the contractor for extension of time shall not be a bar for giving a fair and reasonable extension by the Institute and this shall be binding on the contractor.

Clause 7: Interim/ running bill payments:

No payment shall be made for work, estimated to cost Rs. One lakh or less till after the whole of the work shall have been completed and certificate of completion given. For works estimated to cost over Rs. One lakh, the interim or running account bills shall be submitted by the contractor for the work executed on the basis of such recorded measurements on the format of the Department in triplicate on or before the date of every month fixed for the same by the Engineer-in-Charge [or on or before 15th day of every month, in case no time is fixed by the Engineer in-charge]. The contractor shall not be entitled to be paid any such interim payment if the gross work done together with net payment/ adjustment of advances for material collected, if any, since the last such payment is less than the amount **Rupees Twenty lakh**, in which case the interim bill shall be prepared on the appointed date of the month after the requisite progress is achieved. Engineer-in-Charge shall arrange to have the bill verified by taking or causing to be taken, where necessary, the requisite measurements of the work. In the event of the failure of the contractor to submit the bills, no claims whatsoever due to delays on payment including that of interest shall be payable to the contractor. Payment on account of amount admissible shall be made by the Engineer-in-Charge certifying the sum to which the contractor is considered entitled by way of interim payment at such rates as decided by the Engineer-in-Charge. The

amount admissible shall be paid **by 15 working day** after the day of presentation of the bill by the Contractor to the Engineer-in-Charge [together with the account of the material issued by the department if any], or dismantled materials, if any. All such interim payments shall be regarded as payment by way of advances against final payment only and shall not preclude the requiring of bad, unsound and imperfect or unskilled work to be rejected, removed, taken away and reconstructed or re-erected. Any certificate given by the Engineer-in-Charge relating to the work done or materials delivered forming part of such payment, may be modified or corrected by any subsequent such certificate(s) or by the final certificate and shall not by itself be conclusive evidence that any work or materials to which it relates is/are in accordance with the contract and specifications. Any such interim payment, or any part thereof shall not in any respect conclude, determine or affect in any way powers of the Engineer-in-Charge under the contract or any of such payments be treated as final settlement and adjustment of accounts or in any way vary or affect the contract.

Pending consideration of extension of date of completion, interim payments shall continue to be made as herein provided without prejudice to the right of the department to take action under the terms of this contract for delay in the completion of work, if the extension of date of completion is not granted by the competent authority.

Clause 8: Completion of work - completion certificate:

Within ten days of the completion of the work, the contractor shall give notice of such completion to the Engineer-in-Charge and within thirty days of the receipt of such notice, the Engineer-in-Charge shall inspect the work and if there is no defect in the work, shall furnish the contractor with a final certificate of completion, otherwise a provisional certificate of physical completion indicating defects (a) to be rectified by the contractor and/or (b) for which payment will be made at reduced rates, shall be issued. But no final certificate of completion shall be issued, nor shall the work be considered to be complete until the contractor shall have removed from the premises on which the work shall be executed all scaffolding, surplus materials, rubbish and cleaned off the dirt from all wood work, doors, windows, walls, floor or other parts of the building, in, upon, or about which the work is to be executed or of which he may have had possession for the purpose of the execution; thereof, and not until the work shall have been measured by the Engineer-in-Charge. If the contractor shall fail to comply with the requirements of this Clause as to removal of scaffolding, surplus materials and rubbish as aforesaid and cleaning off dirt on or before the date fixed for the completion of work, the Engineer-in-Charge may at the expense of the contractor remove such scaffolding, surplus materials and rubbish etc., and dispose off the same as he thinks fit and clean off such dirt as aforesaid, and the contractor shall have no claim in respect of scaffolding or surplus materials as aforesaid except for any sum actually realized by the sale thereof.

Clause 9: Payment of final bill:

The final bill shall be submitted by the contractor in the same manner as specified in interim bills within three months of physical completion of the work or within one month of the date of the final certificate of completion furnished by the Engineer-in-Charge whichever is earlier. No further claims shall be made by the contractor after submission of the final bill and these shall be deemed to have been waived and extinguished. Payments of those items of the bill in respect of which there is no dispute and of items in dispute, for quantities and rates as approved by Engineer-in-Charge, will, as far as possible be made within the period specified herein under, the period being reckoned from the date of receipt of the bill by the Engineer-in-Charge, complete [with account of materials issued by the Department and dismantled materials if any]

- | | | |
|-------|---|------------|
| (i) | If the Tendered value of work is up to ₹45 lakh | : 2 months |
| (ii) | If the Tendered value of work is more than ₹45 lakh and up to ₹250 lakh | : 3 months |
| (iii) | If the Tendered value of work exceeds ₹250 lakh | : 6 months |

Clause 10: Materials to be provided by the contractor for approval:

The contractor shall, at his own expense and without delay; supply to the Engineer-in-Charge, samples of material to be used on the work and shall get these approved in advance. All such materials to be provided by the Contractor shall be in conformity with the specifications laid down or referred to in the contract. The contractor shall, if requested by the Engineer-in-Charge furnish proof, to the satisfaction of the Engineer-in-Charge that the materials so comply with the specifications. The Engineer-in-Charge shall, within a reasonable time of supply of samples, intimate to the Contractor in writing whether samples are approved by him or not. If samples are not approved, the Contractor shall forthwith arrange to supply to the Engineer-in-Charge for his approval fresh samples complying with the specifications laid down in the contract. When materials are required to be tested in accordance with specifications, approval of the Engineer-in-Charge shall be issued after the test results are received

The contractor shall, at his risk and cost, make all arrangements and shall provide all facilities as the Engineer-in-Charge may require for collecting, and preparing the required number of samples for such tests at such time and to such place or places as may be directed by the Engineer-in-Charge and bear all charges and cost of testing unless specifically provided for otherwise in the contract or specifications. The Engineer-in-Charge or his authorized representative shall at all times have access to the works and to all workshops and places where work is being prepared or from where materials, manufactured articles or machinery are being obtained for the works and the contractor shall afford every facility and every assistance in obtaining the right to such access.

The Engineer-in-Charge shall have full powers to insist removal from the premises of all materials which in his opinion are not in accordance with the specifications, and in case of default, the Engineer-in-Charge shall be at liberty to employ at the expense of the contractor, other persons to remove the same without being answerable or accountable for any loss or damage that may happen or arise to such materials. The Engineer-in-Charge shall also have full powers to require other proper materials to be substituted thereof, and in case of default, the Engineer-in-Charge may cause the same to be supplied and all costs which may attend such removal and substitution shall be borne by the Contractor.

Clause 11: Mobilization advance:

No mobilization advance is payable under this contract.

Clause 12: Secured advance:

No secured advance for materials is payable under this contract.

Clause 13: Price variation:

The rate quoted by the bidder shall be firm throughout the contract period. No price variation clause is applicable to this contract.

Clause 14: Work to be executed in accordance with Specifications, Drawings, Orders etc.:

The contractor shall execute the whole and every part of the work in the most substantial and workman like manner both as regards materials and otherwise in every respect in strict accordance with the specifications. The contractor shall also conform exactly, fully and faithfully to the design, drawings and instructions of the Engineer-in-Charge.

Clause 15: Deviations in specification:

The Engineer-in-Charge shall have power (i) to make alteration in, omissions from, additions to, or substitutions for the original specifications, drawings, designs and instructions that may appear to him to be necessary or advisable during the progress of the work, and (ii) to omit a part of the works for any reasons; and the contractor shall be bound to carry out the works in accordance with any instructions given to him in writing signed by the Engineer-in-Charge; and such alterations, omissions, additions or substitutions shall form part of the contract as if originally provided therein and any altered, additional or substituted work which the contractor may be directed to do in the manner specified above as part of the works, shall be carried out by the contractor on the same conditions in all respects including price on which he agreed to do the main work.

Clause 16: Power to reduce the scope of work:

If at any time after acceptance of the tender or during the progress of work, the purpose or object for which the work is being done changes due to any supervening cause and as a result of which the work has to be abandoned or reduced in scope, if Institute decide to abandon or reduce the scope of the works for any reasons whatsoever and hence not require the whole or any part of the works to be carried out, the Engineer-in-Charge shall give notice in writing to that effect to the contractor and the contractor shall act accordingly in the matter. The contractor shall have no claim to any payment of compensation or otherwise whatsoever, on account of any profit or advantage which he might have derived from the execution of the works.

Clause 17: Action in case Work not done as per Specifications

If contractor:

- i. At any time, makes default during currency of work or does not execute any part of the work with due diligence and continues to do so even after a notice in writing of 7 days in this respect from the Engineer-in-charge;
- ii. Commits default in complying with any of the terms and conditions of the contract and does not remedy it or takes effective steps to remedy it within 7 days even after a notice in writing is given in that behalf by the Engineer-in-charge; or
- iii. Fails to complete the work(s) or items of work with individual dates of completion, on or before the date(s) so determined and does not complete them within the period specified in the notice given in writing in that behalf by the Engineer-in-charge.

The Institute, without prejudice to any other right or remedy against the contractor which have either accrued or accrue thereafter to the Institute, by a notice in writing to take the part work/part incomplete work of any item(s) out of his hands and shall have powers to:

Carry out part work/part incomplete work of any items(s) by any means at the risk and cost of the contractor.

The Engineer-in-charge shall determine the amount, if any, is recoverable from the contractor for completion of the part work/ part incomplete work of any item(s) taken out of his hands and execute at the risk and the cost of the contractor. If the contractor fails to pay the required sum, the Engineer-in-charge shall have the right to recover the same from any amount due to the contractor.

Clause 18: Recovery of compensation paid to workmen:

In every case, in which by virtue of the provisions sub-section (1) of Section 12, of the Workmen's Compensation Act, 1923, the Institute is obliged to pay compensation to a workman employed by the contractor, in execution of the work, Institute will recover from the contractor the amount of the compensation so paid; and, without prejudice to the rights of the Institute under sub-section (2) of Section 12, of the said Act, Institute shall be at liberty to recover such amount or any part thereof by deducting it from the security deposit or from any sum due by the Institute to the contractor whether under this contract or otherwise. Institute shall not be bound to contest any claim made against it under sub-section (1) Section 12, of the said Act.

Clause 18 A: Ensuring Payment and Amenities to Workers if Contractor fails:

In every case in which by virtue of the provisions of the Contract Labour (Regulation and Abolition) Act, 1970, and of the Contract Labour (Regulation and Abolition) Central Rules, 1971, the Institute is obliged to pay any amounts or wages to a workman employed by the contractor in execution of the works, or to incur any expenditure in providing welfare and health amenities required to be provided under the above said Act, or under the Rules framed by Government from time to time for the protection of health and sanitary arrangements for workers employed by Contractors, the Institute will recover from the contractor the amount of wages so paid or the amount of expenditure so incurred; and without prejudice to the rights of the Institute under sub-section (2) of Section 20, and sub-section (4) of Section 21, of the Contract Labour (Regulation and Abolition) Act, 1970, the Institute shall be at liberty to recover such amount or any part thereof by deducting it from the security deposit or from any sum due by the Institute to the contractor whether under this contract or otherwise the Institute shall not be bound to contest any claim made against it under sub-section (1) of Section 20, sub-section (4) of Section 21, of the said Act.

Clause 19: Labour Laws to be complied by the contractor:

The contractor shall obtain a valid licence under the Contract Labour (R&A) Act 1970, and the Contract Labour (Regulation and Abolition) Central Rules 1971, before the commencement of the work, and continue to have a valid license until the completion of the work. The contractor shall also abide by the provisions of the Child Labour (Prohibition and Regulation) Act, 1986.

The contractor shall also comply with the provisions of the building and other Construction Workers (Regulation of Employment & Conditions of Service) Act, 1996 and the building and other Construction Workers Welfare Cess Act, 1996

The contractor shall also comply with provisions of the Inter-State Migrant Workmen (Regulation of Employment and Conditions of Service) Act, 1979.

The contractor shall comply with the provisions of the Payment of Wages Act, 1936, Minimum Wages Act, 1948; Employees Liability Act, 1938; Workmen's Compensation Act, 1923; Industrial Disputes Act, 1947; Maternity Benefits Act, 1961; and the Contractor's Labour (Regulation and Abolition) Act 1970 and Central Rules; Building and other Construction Workers' (Regulation of Employment and Conditions of Service) Act, 1996; Building and other Construction Workers Welfare Cess Act, 1996, or the modifications thereof or any other laws relating thereto and the rules made thereunder from time to time. The contractor shall indemnify and keep indemnified the Institute against payments to be made under and for the observance of the laws aforesaid. The laws aforesaid shall be deemed to be a part of this contract and any breach thereof shall be deemed to be a breach of this contract.

Any failure to fulfill this requirement shall attract the penal provisions of this contract arising out of the resultant non-execution of the work.

Clause 20: Work not to be sublet. Action in case of insolvency:

The contract shall not be assigned or sublet without the written approval of the Institute. And if the contractor shall assign or sublet his contract, or attempt to do so, or become insolvent or commence any insolvency proceedings or make any composition with his creditors or attempt to do so, or if any bribe, gratuity, gift, loan, perquisite, reward or advantage pecuniary or otherwise, shall either directly or indirectly, be given, promised or offered by the contractor, or any of his servants or agent to any public officer or person in the employ of Institute in any way relating to his office or employment, or if any such officer or person shall become in any way directly or indirectly interested in the contract, the Engineer-in-Charge on behalf of the Institute shall have power to adopt the course specified in Clause 5 hereof in the interest of the Institute and in the event of such course being adopted, the consequences specified in the said Clause 5 shall ensue.

All sums payable by way of compensation under any of these conditions shall be considered as reasonable compensation to be applied to the use of Institute without reference to the actual loss or damage sustained and whether or not any damage shall have been sustained.

Clause 21: Changes in firm's constitution to be intimated:

Where the contractor is a partnership firm, previous approval in writing of the Institute shall be obtained before any change is made in the constitution of the firm. Where the contractor is an individual or a Hindu undivided family business concern, such approval as aforesaid shall likewise be obtained before the contractor enters into any partnership agreement where under the partnership firm would have the right to carry out the works hereby undertaken by the contractor. If previous approval as aforesaid is not obtained, the contract shall be deemed to have been assigned in contravention of Clause 20 hereof and the same action may be taken, and the same consequences shall ensue as provided in the said Clause 20

Clause 22: Work to be executed under the directions of the Engineer in-charge:

All works to be executed under the contract shall be executed under the direction and subject to the approval in all respects of the Engineer-in-Charge who shall be entitled to direct at what point or points and in what manner they are to be commenced, and from time to time carried on.

Clause 23: Contractor to indemnify against Patent Rights:

The contractor shall fully indemnify and keep indemnified the Institute against any action, claim or proceeding relating to infringement or use of any patent or design or any alleged patent or design rights and shall pay any royalties which may be payable in respect of any article or part thereof included in the contract. In the event of any claims made under or action brought against Government in respect of any such matters as aforesaid, the contractor shall be immediately notified thereof and the contractor shall be at liberty, at his own expense, to settle any dispute or to conduct any litigation that may arise therefrom, provided that the contractor shall not be liable to indemnify the Institute if the infringement of the patent or design or any alleged patent or design right is the direct result of an order passed by the Engineer -in-Charge in this behalf.

Clause 24: Settlement of disputes and Arbitration

Except where otherwise provided in the contract, all questions and disputes relating to the meaning of the specifications, design, drawings and instructions here-in before mentioned and as to the quality of workmanship or materials used on the work or as to any other question, claim, right, matter or thing whatsoever in any way arising out of or relating to the contract, designs, drawings, specifications, estimates, instructions, orders or these conditions or otherwise concerning the works or the execution or failure to execute the same whether arising during the progress of the work or after the cancellation, termination, completion or abandonment thereof shall be dealt with as mentioned hereinafter:

- (i) If the contractor considers any work demanded of him to be outside the requirements of the contract, or disputes any drawings, record or decision given in writing by the Engineer-in-Charge **or if the Engineer in Charge considers any act or decision of the contractor** on any matter in connection with or arising out of the contract or carrying out of the work, to be unacceptable and is disputed, **such party** shall promptly within 15 days **of the arising of the disputes** request the Director **of the Institute, who shall refer the disputes to Dispute Redressal Committee (DRC)** within 15 days along with a list of disputes with amounts claimed if any in respect of each such dispute. The Dispute Redressal Committee (DRC) shall give the opposing party two weeks for a written response, and, give its decision within a period of 60 days **extendable by 30 days by consent of both the parties** from the receipt of **reference from Director**. Provided that no party shall be represented before the Dispute Redressal Committee by an advocate/legal counsel etc. If the Dispute Redressal Committee (DRC) fails to give its decision within the aforesaid period or any party is dissatisfied with the decision of Dispute Redressal Committee (DRC) or expiry of time limit given above, then either party may within a period of 30 days from the receipt of the decision of Dispute Redressal Committee (DRC), give notice to the Director for appointment of arbitrator on prescribed format under intimation to the other party. It is a term of contract that each party invoking arbitration must exhaust the aforesaid mechanism of settlement of claims/disputes prior to invoking arbitration.

The Director of the Institute shall in such case appoint the sole arbitrator or one of the three arbitrators as the case may be within 30 days of receipt of such a request and refer such disputes to arbitration. Wherever the Arbitral Tribunal consists of three Arbitrators, the contractor shall appoint one arbitrator within 30 days of making request for arbitration or of receipt of request by Engineer-in-charge to the Director for appointment of arbitrator, as the case may be, and two appointed arbitrators shall appoint the third arbitrator who shall act as the Presiding Arbitrator. In the event of

- a. A party fails to appoint the second Arbitrator, or
b. The two appointed Arbitrators fail to appoint the Presiding Arbitrator, then the Building and Works Committee of the Institute shall appoint the second or Presiding Arbitrator as the case may be.

- (ii) Disputes or difference shall be referred for adjudication through arbitration by a Tribunal having sole arbitrator where Tendered amount is ₹100 Crore or less. Where Tendered Value is more than ₹100 Crore, Tribunal shall consist of three Arbitrators as above.

The requirements of the Arbitration and Conciliation Act, 1996 (26 of 1996) and any further statutory modifications or re-enactment thereof and the rules made there under and for the time being in force shall be applicable.

It is a term of this contract that the party invoking arbitration shall give a list of disputes with amounts claimed, if any, in respect of each such dispute along with the notice for appointment of arbitrator and giving reference to the decision of the DRC. It is also a term of this contract that any member of the Arbitration Tribunal shall be a Graduate Engineer with experience in handling public works engineering contracts at a level not lower than Chief Engineer (Joint Secretary Level of Government of India). This shall be treated as a mandatory qualification to be appointed as arbitrator.

Parties, before or at the time of appointment of Arbitral Tribunal may agree in writing for fast track arbitration as per the Arbitration and Conciliation Act, 1996 (26 of 1996) as amended in 2015.

Subject to provision in the Arbitration and Conciliation Act, 1996 (26 of 1996) as amended in 2015 whereby the counter claims if any can be directly filed before the arbitrator without any requirement of reference by the appointing authority, the arbitrator shall adjudicate on only such disputes as are referred to him by the appointing authority and give separate award against each dispute and claim referred to him and in all cases where the total amount of the

claims by any party exceeds ₹1,00,000 (Rupees One lakh), the arbitrator shall give reasons for the award. It is also a term of the contract that if any fees are payable to the arbitrator, these shall be paid as per the Act.

The place of arbitration shall be NITK, Surathkal or as determined by the arbitral tribunal in consultation with both the parties.

Clause 25: Withholding and lien in respect of sum due from contractor:

25.1 Whenever any claim or claims for payment of a sum of money arises out of or under the contract or against the contractor, the Institute shall be entitled to withhold and also have a lien to retain such sum or sums in whole or in part from the security, if any deposited by the contractor and for the purpose aforesaid, the Institute shall be entitled to withhold the security deposit, if any, furnished as the case may be and also have a lien over the same pending finalisation or adjudication of any such claim. In the event of the security being insufficient to cover the claimed amount or amounts or if no security has been taken from the contractor, the Institute shall be entitled to withhold and have a lien to retain to the extent of such claimed amount or amounts referred to above, from any sum or sums found payable or which may at any time thereafter become payable to the contractor under the same contract or any other contract with the Institute or any contracting person through the Engineer- in-Charge pending finalization of adjudication of any such claim.

It is an agreed term of the contract that the sum of money or moneys so withheld or retained under the lien referred to above by the Institute will be kept withheld or retained as such by the Institute till the claim arising out of or under the contract is determined by the arbitrator (if the contract is governed by the arbitration clause) or by the competent court, as the case may be and that the contractor will have no claim for interest or damages whatsoever on any account in respect of such withholding or retention under the lien referred to above and duly notified as such to the contractor. For the purpose of this clause, where the contractor is a partnership firm or a limited company, Institute shall be entitled to withhold and also have a lien to retain towards such claimed amount or amounts in whole or in part from any sum found payable to any partner/limited company as the case may be, whether in his individual capacity or otherwise.

25.2 The Institute shall have the right to cause an audit and technical examination of the works and the final bills of the contractor including all supporting vouchers, abstract, etc., to be made after payment of the final bill and if as a result of such audit and technical examination any sum is found to have been overpaid in respect of any work done by the contractor under the contract or any work claimed to have been done by him under the contract and found not to have been executed, the contractor shall be liable to refund the amount of over-payment and it shall be lawful for the Institute to recover the same from him in the manner prescribed in sub-clause (1) of this clause or in any other manner legally permissible; and if it is found that the contractor was paid less than what was due to him under the contract in respect of any work executed by him under it, the amount of such under payment shall be duly paid by the Institute to the contractor, without any interest thereon whatsoever.

Clause 26: Arranging all Tools and Plants by the contractor:

The contractor shall arrange at his own expense all tools, plant, machinery and equipment (hereinafter referred to as T&P) required for execution of the work.

Clause 27: All taxes payable by the contractor:

27.1 GST, Building and other Construction Workers Welfare Cess or any other tax, levy or Cess in respect of input for or output by this contract shall be payable by the contractor and Institute shall not entertain any claim whatsoever in this respect. The rate quoted by the contractor shall be inclusive of all these taxes and Cess.

27.2 All tendered rates shall be inclusive any tax, levy or cess applicable on last stipulated date of receipt of tender including extension if any. No adjustment i.e. increase, or decrease shall be made for any variation in the rate of GST, Building and Other Construction Workers Welfare Cess or any tax, levy or cess applicable on inputs. However, effect of variation in rates of GST or Building and Other Construction Workers Welfare Cess or imposition or repeal of any other tax, levy or cess applicable on output of the works contract shall be adjusted on either side, increase or decrease.

Provided further that for Building and Other Construction Workers Welfare Cess or any tax (other than GST), levy or cess varied or imposed after the last date of receipt of tender including extension if any, any increase shall be reimbursed to the contractor only if the contractor necessarily and properly pays such increased amount of

taxes/levies/ cess. Provided further that such increase including GST shall not be made in the extended period of contract for which the contractor alone is responsible for delay as determined by authority for extension of time.

The contractor shall keep necessary books of accounts and other documents for the purpose of this condition as may be necessary and shall allow inspection of the same by a duly authorized representative of the Government and/or the Engineer-in-Charge and shall also furnish such other information/document as the Engineer-in-Charge may require from time to time.

The contractor shall, within a period of 30 days of the imposition of any such further tax or levy or cess, give a written notice thereof to the Engineer-in-Charge that the same is given pursuant to this condition, together with all necessary information relating thereto.

Clause 28: Terminating the contract without compensation:

Without prejudice to any of the rights or remedies under this contract, if the contractor dies, the Institute shall have the option of terminating the contract without compensation to the contractor.

Clause 29: Defects liability period:

The defects liability period of the work shall be **24 months** from the date of completion of work as recorded in the Completion Report recorded by the Engineer in-charge. All maintenance and repair works be carried out during the defect's liability period by the contractor free of cost.

Clause 30: Release of EMD and Security Deposit:

Release of EMD and Security Deposit of the work shall not be refunded till the contractor produces a clearance certificate from the Engineer in-charge (and Concerned Labour Officer, as the case maybe). As soon as the work is virtually complete, the contractor shall apply for the clearance certificate to the Labour Officer under intimation to the Engineer-in-Charge. The Engineer-in-Charge, on receipt of the said communication, shall write to the Labour Officer to intimate if any complaint is pending against the contractor in respect of the work. If no complaint is pending, on record till after 3 months after completion of the work and/or no communication is received from the Labour Officer to this effect till six months after the date of completion, it will be deemed to have received the clearance certificate and the Security Deposit will be released if otherwise due.

Special Conditions of Contract:

1. Permission for working beyond the normal working hours of the Institute or on Saturdays, Sundays and Public holidays as stipulated by the Institute will be given to the Contractor subject to prior approval from the Institute.
2. The Contractor and his workers/ agents shall be required to obtain from the Institute and display the **Photo Identity Card** during entry, stay and exit from the campus areas guarded by the Security personnel.
3. All applications for **issuance of Photo Identity Cards** shall be routed through the Engineer in charge, who shall forward the same to the concerned department, the Section concerned will issue Photo Identity Card to the Contractor or his authorized agent on payment of necessary fees as prescribed from time to time and the same will be for duration of the Contract or a period of one year, whichever is less.
4. Duties of the Representatives of Engineer in charge are to watch and supervise the works and to test and examine any materials to be used or workmanship employed in connection with the works. He shall have no authority to relieve the Contractor or any of his duties or obligations under the Contract. Any written instructions or approval given by the Representative of Engineer in charge to the Contractor within the terms of the above shall bind the Contractor as though it had been given by the Engineer in charge provided always as follows:
 - Failure of the Representative of Engineer-in-charge to disapprove any work or materials shall not prejudice the power or the Engineer-in-charge thereafter to disapprove such works or materials and to order pulling down, removal or breaking up thereof.
 - If the Contractor shall be dissatisfied by the reason of any decision of the Representative of Engineer in charge, he shall be entitled to refer the matter to the Engineer-in-charge who shall thereupon confirm, reverse or vary such decision.
5. No labour hutments shall be erected within campus area and no labourers are allowed to stay within campus area after the working hours other than contractors' watchmen kept for safeguarding his materials, subject to prior approval from the Institute.
6. Quantities of items in the Schedule of Quantities are indicative only and Contractors claims shall be limited to actual measured quantities only. Since the actual quantity at site may vary to any extent, the rate quoted must be reasonable and should be based on market survey.
7. No materials will be supplied by the Institute. All the materials used in the work shall be conforming to relevant ISI specification or as specified in the Tender Schedule or as directed.
8. Contractor shall undertake such laboratory test as specified in the relevant ISI at the Institutes testing lab or any other approved testing lab at the discretion of The Institute and only approved materials/ approved brand of materials shall be used. All the tests shall be carried out at the expense of Contractor. Various test Reports in original shall be made available to the Engineer in charge as and when the tests are carried out. Test samples shall be selected by the Representative of Engineer in charge only.
9. The expression the Period of Maintenance shall mean the Period of Maintenance named in the Tender calculated from the date of completion of the works certified by the Engineer in charge in accordance with the relevant clause.
10. To the intent that the works shall or as soon as practicable after the expiration of the period of maintenance be delivered up to the Institute in as good and perfect condition (fair wear and tear expected) to the satisfaction of the Engineer in charge as that in which they were at the commencement of the period of maintenance, the Contractor shall execute all such work of repairs, amendments, reconstructions, rectification and making good of defects, imperfections, shrinkages or other faults as may be required.
11. All such maintenance work shall be carried out by the Contractor at his own expenses, if the necessity thereof shall in the opinion of the Engineer in charge be due to the use of materials or workmanship not in accordance with the Contract or to or failure on the part of the Contractor to comply with any obligation expressed or implied on the Contractors part under the Contract, even though the work may have been previously passed or even if the Contractors attention had not been drawn to the unsatisfactory nature thereof.
12. If the Contractor fails to do any such work as aforesaid required by the Engineer in charge, the Institute shall be entitled to carry out such work by their own workmen or by other Contractors and if such work is work which the

Contractor should have carried out at the Contractor's own cost shall be entitled to recover from the Contractor the cost thereof or may deduct the same from any monies due or that become due to the Contractor

(a) **Engineer in charge** shall during the progress of the works have **power** to order in writing from time to time.

- The removal from the site within such times as may be specified in the order or any materials which in the opinion of the Engineer in charge are not in accordance with the Contract.
- The substitution of proper and suitable materials
- The removal and proper re-examination (notwithstanding any previous test or interim payment therefore) or any work which in respect of materials or workmanship is not in the opinion of the Engineer in charge are not in accordance with the Contract.

(b) In case of default on the part of Contractor in carrying out such order the Engineer in charge shall be entitled to employ and pay other persons to carry out the same and all expenses consequent thereon or incidental thereto shall be borne by the Contractor and shall be recoverable from him by the Institute or may be deducted by the Institute from any monies due or may become due to the Contractor.

13. All the clauses/ conditions/ instructions are part of the Contract and any breach thereof shall be deemed as breach of Contract.
14. If the rate/ rates quoted by the Contractor are differs for the same similar item in the various parts of the same Contract in the Schedule of Quantities and Rates, only lowest rate shall be considered for computing amount due to him.
15. In case Consulting Engineer for the work is being appointed by the National Institute of Technology Karnataka, Surathkal, they will superintend the work and Contractor shall carry out all the instructions/ directions. Such direction/ instructions must have the endorsement from the Engineer in charge.
16. These Special Instructions, Additional Instructions shall prevail over similar clauses mentioned elsewhere. The several Documents forming the Contract are to be taken as mutually explanatory of one another. In case of conflict in interpretation of Contract Documents, the following of precedence shall prevail.
- a. Tender /Contract conditions, Special conditions, Additional conditions,
 - b. With regard to overall scope of work the order of priority of documents for interpretation is Agreement, Letter of Acceptance, Letter of Intent, Tender Documents.
 - c. With regard to the conditions of the contract, the order of priority of Tender Documents for interpretation is Tender Form, Definition & Interpretation, Special Instructions, General Additional Instructions, and Tender Conditions of NITK / CPWD latest edition with all amendments. Electrical Installation Specifications, Instructions – Electrical Works.
 - d. With regard to description of work the order of priority is in the following order – Schedule of Quantities, Drawings, Specifications (KPWD), Specifications (CPWD), Specifications (BIS)
 - e. In case of drawings, written dimensions shall prevail over scaled dimensions. Enlarged details and detailed drawing shall prevail over General plan, Sections, elevations etc.
 - f. In case of any ambiguity/ obscurity in the interpretation of clauses/ conditions/ specifications/ drawings etc. decision of the Director is final and binding.
 - g. Any apparent errors or **omission in drawings** or specifications or instruction issued by the representative of Engineer in charge shall be brought to the notice of the Engineer in charge as the documents have been made available to him. The Engineer in charge shall correct such errors or omissions. The Contractor shall neither be eligible for any additional cost, extension of time etc. on this account nor shall he be permitted to take advantage thereof.
17. Contractor shall make his **own arrangement for Electricity** required for the and nothing extra will be paid for the same. The contractor will not be allowed to put up any tapping point for power from the Employer's power source.
- (a) Distribution arrangements shall be done by the Contractor at his cost as per approved layout. He shall provide required clearance for overhead lines to facilitate easy movements of machinery. These overhead lines shall be shifted and rerouted at Contractor's cost during execution of work if the same are found to obstruct any other work of any agency working at site or requires to be shifted due to unforeseen reasons.
 - (b) On completion of the work, the Contractor shall, to the satisfaction of the Engineer in charge, remove all wiring installed by him and make good, disturbance or damage is done.
 - (c) The Contractor shall employ a certified and licensed Electrician for carrying out his works.
 - (d) All temporary and permanent electrical installations, power distribution and supply required for execution of work shall be carried out conforming to existing industrial and domestic safety rules and regulations.

- Important specific points to be noted are as under. (e) Meter room and main switches should be freely accessible at all times and fully protected against all weather conditions.
- (f) Power distribution system shall be identifiable with display marking on switches.
 - (g) All power distribution shall be carried out with coated, adequately insulated and appropriate current/ load rating cables. It shall be securely routed for this purpose. No loose, naked, hanging wires shall be permitted.
 - (h) Overload protection devices shall be installed whenever and wherever heavy current/ load consuming construction plant or machinery susceptible to hazard is in use and as directed by Engineer in charge.
 - (i) Metallic plugs and sockets shall be used in field work. Switch board shall be in close proximity so as to have quick control over supply.
 - (j) Proper and adequate earthing connection should be provided for all installations, plant and machinery and distribution system.
 - (k) Hand lamps and inspection lamps shall be adequately insulated and guarded with wire mesh and proper plugs for use.
 - (l) Security and illuminator light shall be secured firmly and protected to with stand weather condition.
18. All scaffolds, ladders and other **safety devices** mentioned or described herein shall be maintained in a safe condition and no scaffold, ladder or equipment shall be altered or removed while it is in use.
19. All necessary personal **safety equipment** as considered adequate by the Engineer shall be available for use of persons employed on the site and maintained in a condition suitable for immediate use and the contractor shall take adequate steps to ensure proper use of equipment by those concerned.
- a. Workers employed on mixing asphaltic materials, cement and lime mortars/ concrete shall be provided with protective footwear and protective gloves.
 - b. Those engaged in handling any materials which are injurious to eyes shall be provided with protective goggles.
 - c. Workers employed on erection works etc. shall be provided with helmets, safety belts etc.
 - d. Workers employed on concrete finishing, welding, painting and other works above 2metres height shall be provided with a suitable safety belt, as per the factory rules of the locality.
20. The contractor shall take approval from the Resident Engineer of the employer for storing the lubricants, oil, and fuel at site for running the machinery required for construction and also obtaining statutory permission from concerned authorities to store such combustibles if required.
21. Suitable, sufficient **fire extinguishers** for all types of fire shall be provided at the work site. In addition, sufficient number of fire buckets filled with water and sand shall also be provided. The firefighting equipment as outlined above shall be located in purposeful manner at various possible fire hazards places within the site.
22. Contractor shall limit all his activities within the area earmarked for the purpose. He shall **maintain ecological balance** by preventing deforestation, water pollution and defacing of natural landscape. He shall carry out his activities as prevent any avoidable destruction or defacing of natural surroundings in the vicinity of work.
23. The Contractor will attend the **Site meetings** a fixed by the Engineer in charge from time to time discuss all issues relating to the works in general and progress and regarding quality control.
24. **A site order book** shall be kept at the site of the work in safe custody and made it available as when required and should not be tampered with. As far as possible, all orders regarding the works are to be entered in this book. All entries therein shall be signed by the Engineer in charge or his representative and the Contractor or his representative. In important cases, the Engineer in charge will counter sign the entries, which have been made. The site order book shall not be removed the work site except with the written permission of the Engineer in charge and the Contractor or his representative shall bound to take note of all instructions and directions meant for the Contractor as entered in the site order book without having to be called on separately to note them. The Contractor shall do compliance of the noting in site order book within three days of noting. In case of failures to do so, the corresponding work shall be stopped and work already done shall not be accepted.
25. It is for the Contractor to provide the **safe and guarded access** for Engineer in charge as detailed in the safety code for the inspection of works, the Contractor shall arrange at his cost required ladders, scaffolding materials, steel measuring tapes, plumb levels, Theodolite or any other instruments required by the Engineer in charge for his use at site. The Engineer in charge or his authorized representative shall at all times have access to the works and to all workshops and places where work is being prepared or from where materials, manufactured articles or machinery are

being obtained for the works the Contractor shall extend every facility for and every assistance in or obtaining the right to such access.

26. No works shall be covered up or put out of view without the approval of the Engineer in charge and the Contractor shall afford full opportunity for the Engineer in charge to **examine and measure any Work** which is about to be covered up or put out of view and to examine foundations before permanent work is placed thereon. The Contractor shall give due notice to the Engineer whenever any such works are ready or about to be ready for examination and the Engineer shall, without unreasonable delay, unless he considers it unnecessary and advises the Contractor accordingly, attend for the purpose of examining and measuring such work or of examining such foundations.
27. Contractor shall uncover any part or parts of the Works or make openings in or through the same as the Engineer may from time to time direct and shall reinstate and make good such part or parts to the satisfaction of the Engineer. If any such part or parts have been covered up or put out of views after compliance with the requirement as above said and are found to be executed in accordance with the Contract, the expenses of uncovering, making openings in or through, reinstating and making good the same shall be borne by the Employer, but in any other case all costs shall be borne by the Contractor.
28. Labour Cess is applicable to this Contract as per Labour Act is in force. Cess will be collected from the gross amount of each Running Bills at the prevailing rate as prescribed in the relevant Labour Act in force.
29. A reference made to Indian Standard Specification in the Tender Document, shall imply reference to latest version of that Standard, including such revision/ amendments as may be issued during the currency of contract and corresponding clause/s therein shall valid in place of referred to.
30. The following defects are to be rectified/repairs are to be done during the entire defect liability period from date of completion:
 - (i) In case of Termite in Ply board or Block board or any other Board installed, the entire affected sheet shall be replaced.
 - (ii) Defects in castors
 - (iii) Peeling off of PVC lipping from edges
 - (iv) Cracks in lamination
 - (v) Fading /peeling off of powder coating or paint or anodic coating or any other coat /veneer
 - (vi) Breaking/Cracking of Ply wood or Block board or any other board
 - (vii) Rusting of any metallic part
 - (viii) Tightening of screws/slides/fasteners/guide fixtures/gaskets/ washers/ bolts/ nuts/ clamps/ brackets/ rollers/ castors/ hardware etc.
 - (ix) Any other defect as notified by the Engineer-in-Charge
31. The contractor shall provide necessary cut out for computer, telephone and power outlets as per the approved sample/ shop drawing without any extra cost to the department.
32. All the edges of the Block boards except those which are post formed shall be sealed with PVC edge banding tape of 2mm thickness and have primer at the back. The edge banding tape shall be rounded to a radius of 2mm to 3mm at hot edges and must not melt, and to be glued on edge banding machine.
33. All the post formed tops, work surfaces etc. shall have balancing amination on the unexposed surface.
34. For any tests as directed by the Engineer-in-charge that have to be carried out at an outside laboratory, the cost of materials, transport etc., shall be borne by the contractor.
35. The samples shall be provided by the Agency free of cost. The testing shall be carried out in any Govt. Lab./Public Undertaking Lab./IIT or NIT Lab./ Government Engineering University or any other lab as approved by Engineer-in-charge .
36. While installation of modular furniture, existing flooring including any carpeting, tiling, sheets etc shall be protected by using PVC sheet/ card board/ foam sheet to avoid scratches/ damages for which nothing extra shall be paid.

DEFINITIONS AND INTERPRETATIONS

1. **DEFINITIONS:** The following terms shall have the meaning hereby assigned to them except where the context otherwise requires:
 - 1.1 **INSTITUTE / NITK, Surathkal**

Shall mean National Institute of Technology Karnataka, Surathkal, Post Srinivasnagar, Mangaluru – 575 025, represented by its Director or Registrar or their authorized representatives.

The **Director** means the Director of the Institute.

The **Registrar** means the Registrar of the Institute.

The **Engineer in charge** of the Institute shall mean the Engineer in charge of the work [Resident Engineer or the Executive Engineer]
 - 1.2 **CONTRACTOR**

Shall mean the successful bidder to whom the contract has been awarded which expression shall unless the context otherwise requires, include his legal heirs, executors, administrators and assigns.
 - 1.3 **CONTRACT; CONTRACT AGREEMENT**

Shall mean and include the following:

Notice inviting tender; tender document containing general instructions to the bidder and conditions of contract; scope of work; clauses of contract etc., documents furnished by the bidder; Letter of Intent; Work order; all related Acts and Rules specified in the tender document; and/or any other correspondences of negotiations and the price bid, all future correspondences.

The **Contract** means the documents forming the tender and acceptance thereof and the formal agreement executed between the competent authority on behalf of the Institute and the Contractor, together with the documents referred to therein including these conditions, the specifications, designs, drawings and instructions issued from time to time by the Engineer-in-Charge and all these documents taken together, shall be deemed to form one contract and shall be complementary to one another.
 - 1.4 **Accepting Authority** shall mean the Director, NITK, Surathkal.
 - 1.5 **Excepted Risk** are risks due to riots (other than those on account of contractor's employees), war (whether declared or not) invasion, act of foreign enemies, hostilities, civil war, rebellion revolution, insurrection, military or usurped power, any acts of Government, damages from aircraft, acts of God, such as earthquake, lightening and unprecedented floods, and other causes over which the contractor has no control and accepted as such by the Accepting Authority.
 - 1.6 **Market Rate** shall be the rate as decided by the Engineer-in-Charge on the basis of the cost of materials and labour at the site where the work is to be executed, all overheads and profits.
 - 1.7 **Schedule(s)** referred to in these conditions shall mean the relevant schedule(s) annexed to the tender papers or the standard Schedule of Rates of the government, with the amendments thereto issued up to the date of receipt of the tender.
 - 1.8 **District Specifications** means the specifications followed by the State Government in the area where the work is to be executed.
 - 1.9 **Tendered value/ Bid amount** means the value of the work as stipulated in the letter of award/ letter of Intent.

APPROVED MAKES OF MATERIAL

Sl. No.	Material	Approved makes
1	CRCA Sheet/ ERW Pipe/ Aluminium /SS Sheets/ SS pipes	TATA, SAIL, Jindal, Hindalco, Indalco or Equivalent
2	Laminate sheets, Veeners	Century, Greenlam, Merino, Godrej, Formica, Decolam, Royal Touch, AICA -Sunmica or Equivalent
3	Boards/Plywood (Particle/ MDF/ HDF)	Century, Greenply, Greenlam, Merino, Asian, Godrej, Novapan, Donear, Royal Touch or Equivalent
4	Hardware items/ Fixtures	Hettich, Hafele, Dorma, Kich, Godrej, Fischer or Equivalent
5	Fabric/ Leatherette	Response, Comrad or Equivalent
6	Glass	Saint Gobain, Modi Guard, Asahi, Glaver bel or Equivalent
7	Paints	ICI, Asian Paints, Berger, Oikos, Nerolac, MRF, Tarfaccoat or Equivalent
8	Glazing Sealant	Dow Corning, GE Sealant or Equivalent
9	Resin based Adhesive	Fevicol, Vamicol or equivalent
10	Locks	Godrej, Dorset, Europa or Equivalent
11	Screws and other hardware	Only Stainless steel (if not mentioned in the BOQ)
12	Adhesive	Fevicol or equivalent

Formats:

Format for details of establishment for which the Agency had provided similar works (similar work means – manufacturing and installation of furniture) during the previous five financial years - To be submitted year-wise in a separate sheet typed neatly, scanned and uploaded.

During the year 2015-16 to 2019-20

Sl. No.	Name of the Department	Contact person, designation and phone number	During the year	Value of work done

Formats:

Format for details of similar contracts in hand - To be submitted in a separate sheet typed neatly, scanned and uploaded.

Sl. No.	Name of the Department	Contact person, designation and phone number	Contract period up to	Contract value of work

Formats:

FORMAT OF AFFIDAVIT

[For Sl. No. 10.7 and 10.8 of Eligibility Criteria specified in the Notice Inviting e-Tenders]

[On a stamp paper of ₹200 duly sworn before the Public Notary/ Oath Commissioner]

Name of work: "Manufacturing, Supply and installation furniture to e-Library Complex in NITK, Surathkal"

Affidavit of Mr./Ms. _____, S/o/ of Mr. _____ aged about _____ years, resident of _____, working as _____(designation) for _____ (name and address of the bidding agency).

I, the above-named deponent, solemnly affirm and state as under:

1. That I am working as _____ /proprietor of the _____ (name of the firm) and authorized to sign this affidavit.
2. That the firm M/s---- (complete address of the firm) has not abandoned or suspended any contract work of any organization/ department so far/ during the previous five financial years.
3. That the firm M/s---- (complete address of the firm) has not been blacklisted/ debarred for competing in tenders by any organization/ department so far/ during the previous five financial years.
4. I solemnly verify that the facts stated above are true and nothing material has been concealed.

Seal and Signature of deponent

Identified by:

Solemnly affirmed and signed before me by the Deponent after the contents of this affidavit were read over to him and stated by him to be true and correct on this ---- day of ----- 2020, at -----.

FORMAT OF INDEMNITY BOND

To be furnished only by the Successful bidder upon intimation

(TO BE NOTORISED ON A STAMP PAPER OF APPROPRIATE VALUE)

Name of the work: "Manufacturing, Supply and installation furniture to e-Library Complex in NITK, Surathkal"

KNOW all men by these presents that M/s ----- (name and address of the agency) do hereby execute Indemnity bond in favour of National Institute of Technology Karnataka, Surathkal, Mangaluru – 575 025 on this ----- day of ----
--

THIS DEED WITNESSETH as follows:

We (Name and address of the contractor) do hereby indemnify and save harmless NITK, Surathkal, Mangaluru – 575 025 from:

Any third-party claims, civil or criminal complaints/ liabilities/ site mishaps and other accidents or disputes; and/ or damages occurring or arising out of any mishap due to my/ our negligence in performing the contract "**Manufacturing, Supply and installation furniture to e-Library Complex in NITK, Surathkal**"

1. Any damages, loss or expenses due to or resulting from any negligence or breach of duty on the part of me/ us or my employees;
2. Any claims by workers of mine/ ours under the Workman Compensation Act or Employees Liability Act or Minimum Wages Act or any other Act/ Law/ Rules and regulations in force from time to time under any Law in respect of injuries to persons or property arising out of in the course of execution of contract and/ or arising out of in the course of employment of any workman/ employee;
3. Any act or omission of mine/ ours which involve any loss or damages or liability or civil or criminal action.

IN WITNESSETH WHEREOF the above named has set his signature on this day-----

Signed and delivered by the aforesaid in the presence of witness:

- 1.
- 2.

FORMAT OF LETTER OF INTENT

N _____

Date:

To:

(Name address of the agency)

Sir,

Sub.: "Manufacturing, Supply and installation furniture to e-Library Complex in NITK, Surathkal"– Letter of Intent – Reg.

Ref.: 1. Notice inviting e-tenders ----- dated -----
2. Your tender dated -----

This is to inform you that subject to the terms and conditions of Notice Inviting e-Tenders referred (1) above and the tender document, your e-tender submitted in e-procurement portal for the above mentioned work has been accepted for ₹----- (Rupees ----- only), which is at -----% below/ above the estimate amount put to tender.

As per Clause ---- of the tender document, you are requested to submit a performance guarantee of ₹----- (Rupees ----- only) by means of Bank guarantee bond of any scheduled bank (should be valid till the time allowed for completion of work [i.e. 45 days] + 120 days) or Fixed Deposit Receipt or Demand Draft drawn in favour of the Director, NITK, Surathkal or through e-payment [RTGS or NEFT] within seven days from the date of issue of this letter.

You are also requested to attend this office within seven days from the date of issue of this letter along with a non-judicial stamp paper of ₹200 for executing an agreement.

You are further requested to submit a certified/ self-attested copy of all the documents uploaded during submitting e-tender on e-procurement portal and original affidavit.

Yours sincerely,

Registrar
NITK, Surathkal.

Copy to:

FORMAT OF AGREEMENT

AGREEMENT FOR the work of **“Manufacturing, Supply and installation furniture to e-Library Complex in NITK, Surathkal”**

THIS AGREEMENT is made on the ----day----- by and between National Institute of Technology Karnataka, Surathkal, an autonomous educational Institute of the MHRD, Government of India imparting technical and science education, represented by its Registrar, hereinafter called the “Institute” of the ONE PART (The expression “Institute” shall include his successors, assigns or transferees)

And

(Name and address of the agency) represented by -----, hereinafter called the contractor, which expression shall, unless excluded by or repugnant to the context, be deemed to include his successors, legal heirs, executors, administrators, representatives of the OTHER PART.

WHEREAS the Institute has called e-tenders for **“Manufacturing, Supply and installation furniture to e-Library Complex in NITK, Surathkal”** vide Notice Inviting Tender No. ----- dated -----.

WHEREAS among several other bidders, M/s ----- have also submitted their offer in response to the said notification. Among several agencies who have offered their bid, the Institute found the tender offered by ----- (Name of the agency) is acceptable and hence offered to grant the contract of **“Manufacturing, Supply and installation furniture to e-Library Complex in NITK, Surathkal”** to them vide Letter of Intent No. ----- dated -----.

Whereas M/s ----- (Name of the agency) has accepted the award of contract. Hence this agreement.

NOW THIS AGREEMENT WITNESSETH as follows:

1. In this agreement, words and expression shall have the same meanings as are respectively assigned to them in the tender document.
2. The following documents shall be deemed to form and be read and construed as part of this agreement, namely
 - (i) Notice inviting Tender No. ----- dated -----.
 - (ii) Tender document containing --- pages.
 - (iii) Documents submitted by the contractor along with his tender (containing – pages)
 - (iv) Letter of Intent No. -----
 - (v) Work order
 - (vi) All future correspondences between the parties
3. In consideration of the payments to be made by the Institute, the contractor hereby covenants with the Institute and agree to execute the work of **“Manufacturing, Supply and installation furniture to e-Library Complex in NITK, Surathkal”** as per the provisions of the contract.
4. The Institute hereby covenants to pay the contractor in consideration of the works rendered by the contractor, the amount specified in the tender document/ price bid as accepted in the letter of intent, as per the actual measurements.

IN WITNESS WHEREOF the parties hereto have signed the agreement the date and year first above mentioned.

Contractor

Institute

Witness:

FORMAT OF WORK ORDER

No.-----

Date:

To:

(Name and address of the agency)

Sir,

Sub.: "Manufacturing, Supply and installation furniture to e-Library Complex in NITK, Surathkal" – Work order – Reg.

Ref.: 1. This office letter of Intent No. ----- dated -----.
2. Agreement dated -----

The agreement dated ----- in respect of the above work for a total contract price of ₹----- (Rupees ----- - only) including GST is accepted. A copy of the agreement is enclosed herewith. You are requested to contact the Resident Engineer, NITK, Surathkal for further instructions. You are requested to take over the site within fifteen days from the date of issue of this work order and start the work. If you fail to take over the site within fifteen days, the fifteenth day from the date of issue of this letter shall be deemed as the date of handing over the site. The time that is allowed to complete the work is 45 days including monsoon from the date of handing over the site. The entire work should be completed within the scheduled time failing which compensation for delay as per related clauses of the agreement shall be imposed. You are requested to submit a "Time and Progress Chart" and get it approved by the Resident Engineer. However, the following milestones shall be adhered while submitting the Progress Chart.

Sl. No.	Financial Progress	Time allowed
1.	1/8 th (of the whole work)	1/4 th (of the whole time)
2.	3/8 th (of the whole work)	1/2 (of the whole time)
3.	3/4 th (of the whole work)	3/4 th (of the whole time)
4.	Full	Full

You are further requested to obtain Labour licence from the Assistant Labour Commissioner (C) as per Contract Labour (Regulation and abolition) Act 1970 and the Central Rules framed there-under and submit a copy of the same to this office for record purpose. Form No. 3 required in this connection is enclosed herewith. You are further requested to submit an Indemnity bond as per the terms of the agreement before starting the work.

Encl: As above

Yours sincerely,

Registrar
NITK, Surathkal.

Copy to:

The bidders are requested to furnish their bank account details in the following format:

Format for submission of details of the bank account of the bidder:

Name of the account holder (bidder)	
Complete address	
Contact number	
Email address	

Bank Account details:

Bank name	
Branch name	
MICR number	
Account type	
Account Number	
Please re-type Account number again	
IFSC code of the Bank	

I hereby declare that the particulars given above are correct and complete. If the transaction is delayed or not effected at all for reasons of incomplete or incorrect information, I would not hold the Institute responsible for this.

I have read the option invitation letter and agree to discharge responsibility expected of me as a participant under the scheme.

Seal and signature of the bidder.

Certification from the banker:

Certified that the particulars furnished above are correct as per our records.

Seal and signature of the authorized officer of the bank.

LOT NO. 01. CHAIRS



LOT NO. 02. MODULAR WORK STATION TABLES: (OPEN DESKING)

MODULAR WORK STATION TABLES: (Open Desking)

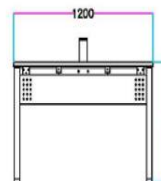
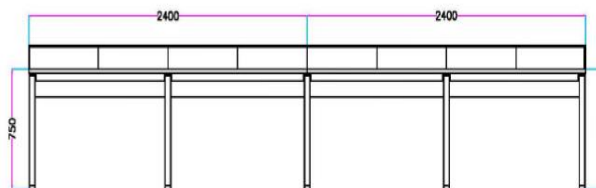
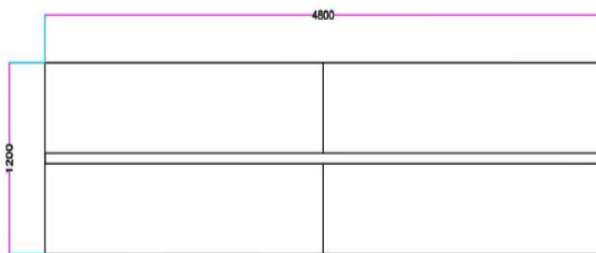
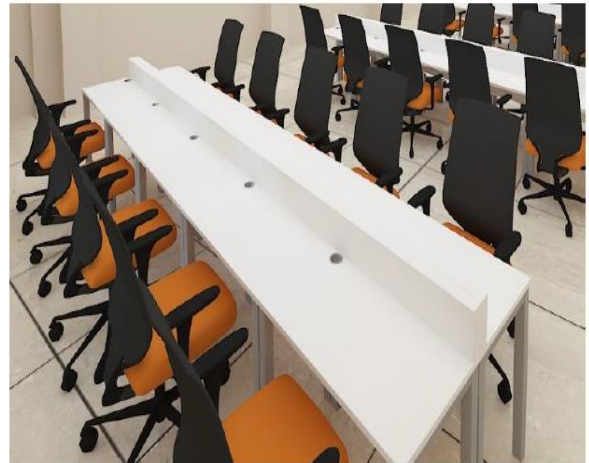

LOT NO. 03. ASSTT. LIBRARIAN TABLE

ASSTT. LIBRARIAN TABLE

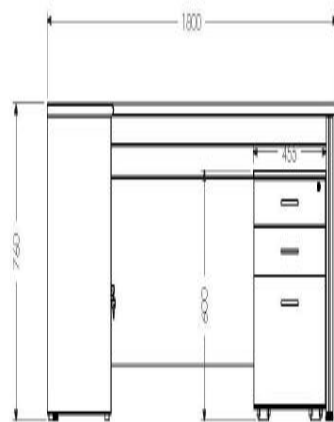
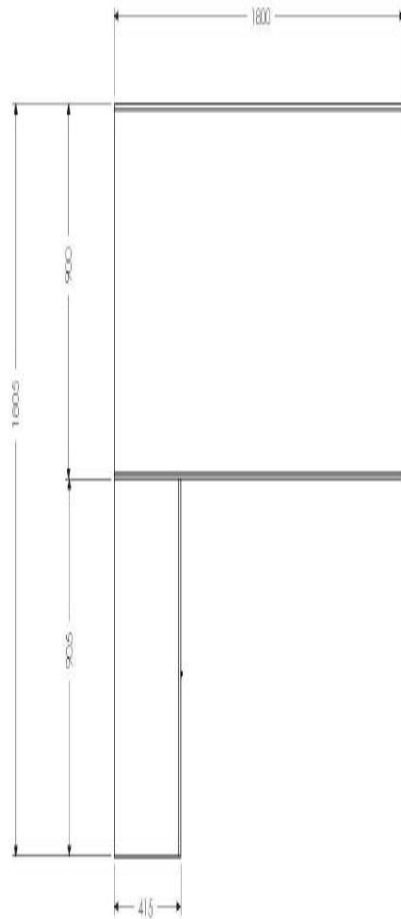

LOT NO. 04. VISITOR CHAIR



LOT NO.05. S.D.U 1200 HT

S.D.U 1200 HT

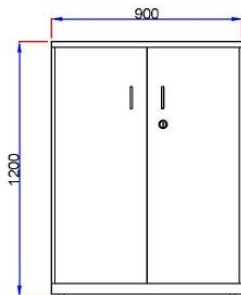
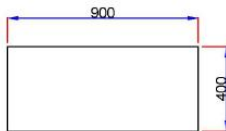

LOT NO. 06. PROPERTY COUNTER HELP DESK TABLE

PROPERTY COUNTER HELP DESK TABLE

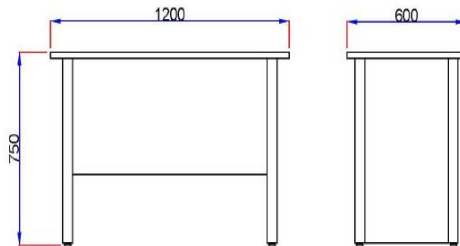
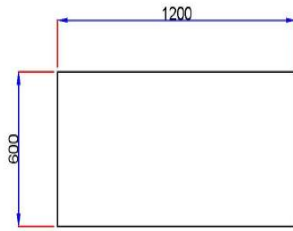

LOT NO. 07. HELP DESK CHAIR



LOT NO. 08. COFFEE TABLE ROUND

Coffee Table Round

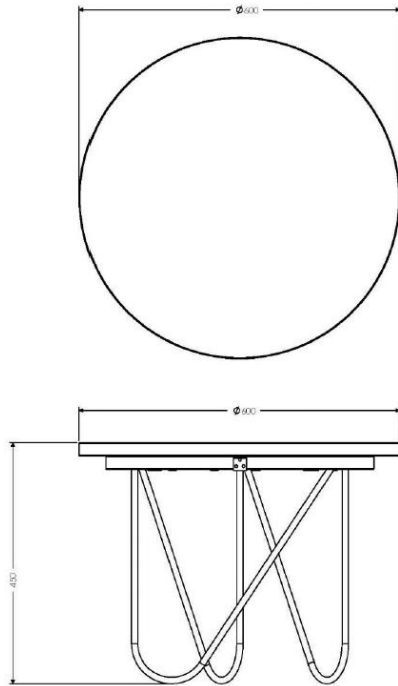

LOT NO. 09. COFFEE TABLE RECTANGLE

Coffee Table Rectangle

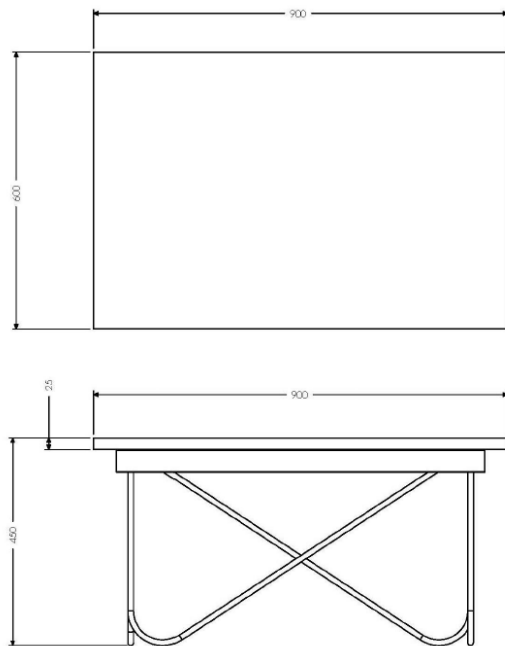

LOT NO. 10. CAFETARIA CHAIRS



LOT NO. 11. READING TABLES

READING TABLE

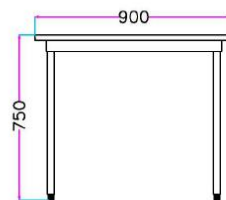
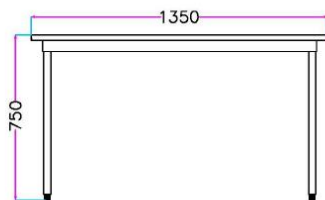
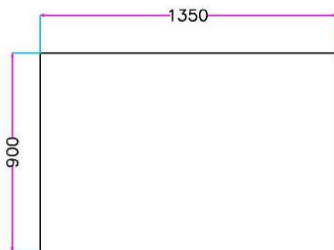

LOT NO. 12. READING TABLE (PLEKTROM TABLE)

Reading Table (Plektrom table)

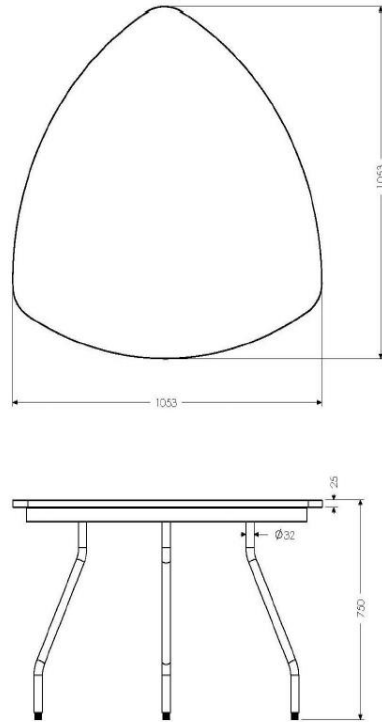

LOT NO.13.ROUND TABLE

ROUND TABLE

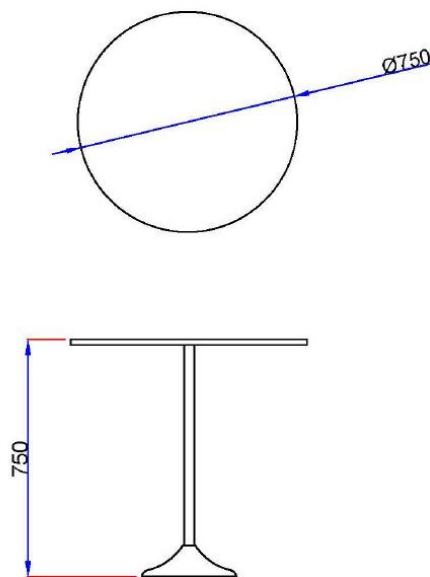

LOT NO. 14. PODIUM CHAIRS



LOT NO. 15. PODIUM TABLES

PODIUM TABLE

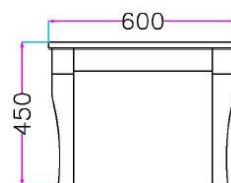
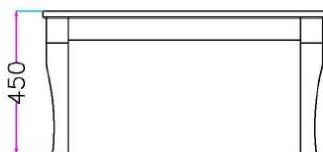
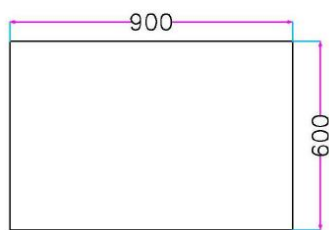

LOT NO. 16. CONFERENCE TABLE

CONFERENCE TABLE / DISCUSSION TABLES

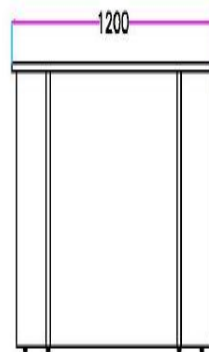
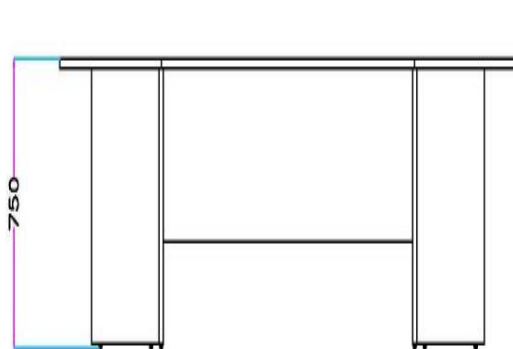
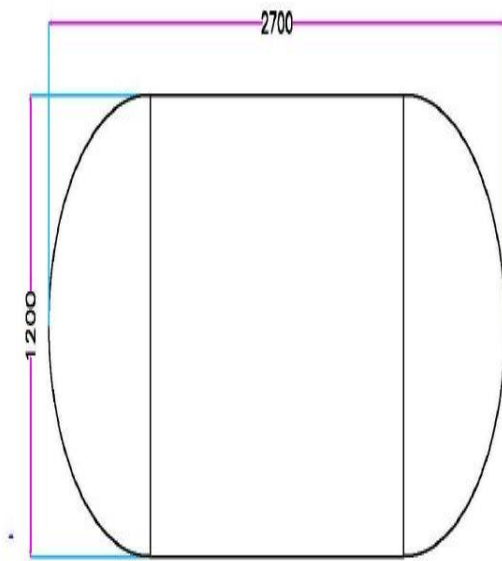

LOT NO. 17. TELE CONFERENCE TABLE

Tele Conference Table

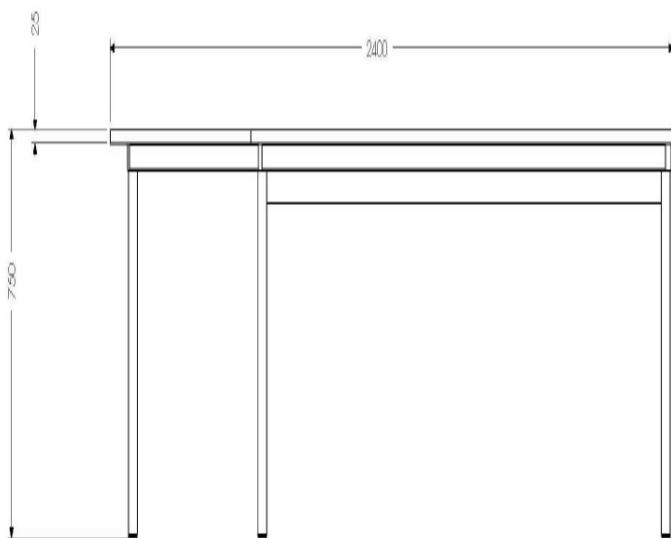
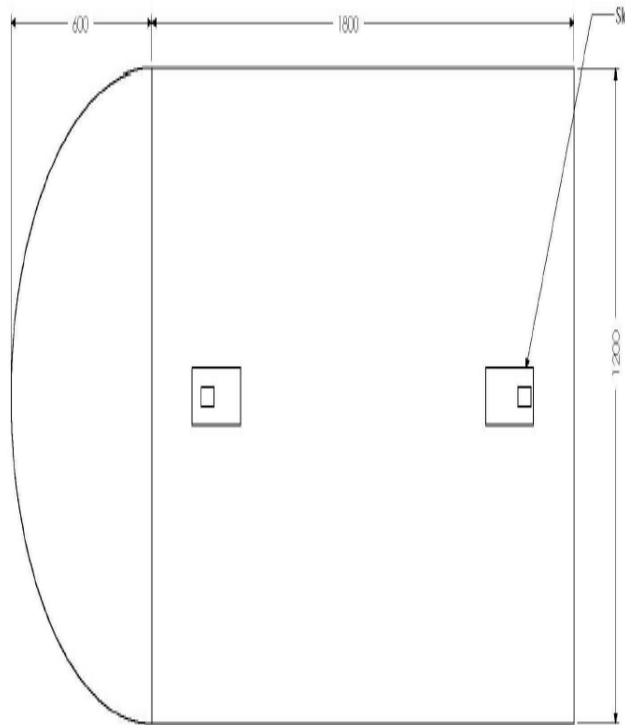

Schedule A: Bill of quantities

(Bid to be quoted only on e-Procurement portal)

The price quoted should be inclusive of cost of all materials, all labour, all lead and lift, all wastage in materials, taxes, cess and royalties on labour and materials, installation of items at the site, contractors overhead and profit margins etc. for successful completion of the work.

Note: Thickness/ measurements mentioned in the specification are finished thickness/ finished measurements.

Lot No	Specification of item to be carried out	Estimated quantity	Unit of measurement	Price quoted per Unit			Amount
				Rate in ₹	GST in ₹	Total in ₹	
-1-	-2-	-3-	-4-	-5-	-6-	-7-	-8-
1	<p><u>CHAIRS</u></p> <p>Specification-Size:H:1000-1100mm, Seat ht: 460-560mm, D-600mm, W-590 mm. 5-Prong nylon base for stability. Twin Wheel heavy Duty Castor for easy mobility under load. Seat Hot pressed ply wood with steel T-Nuts for rigid fastening with PP cover. Back is moulded Bright Bar with stitched Mesh Cloth. Sturdy steel column gas lift for centre support and seat height adjustment. Telescopic ABS cover over steel column. Lockable synchrony tilt mechanism and with Single piece Die castes PP arm rest adjustable with PP pad. Quality tapestry. High density Moulded PU cushion.</p>	30	Nos				
2	<p><u>MODULAR WORK STATION TABLES: (Open Desking)</u></p> <p>Size 4800m L x 1200mm W x 750mm H (set of two table 2400mmL x 1200mm W main+add on) Seating of total 10 people facing each other on each desk Sharing linear workstation Main Desk Made of 25mm thick prelaminated particle board top with pvc edge bending. Under structure of top made up of 50mm x 50mm x 1.6mm thick & 40mm x 40mm x 1.6mm thick erw tube. with provision of horizontal & vertical cable tray made up of 0.8mm cold rolled close annealed sheet curved with bottom & side pillar. All steel components are epoxy powder coated followed by seven tanks anti corrosion treatment</p>	10	Set				

03	<p><u>ASST. LIBRARIAN TABLE</u></p> <p>TABLE WITH KEYBOARD TRAY, MOBILE PEDESTAL, AND ERU UNIT, Overall Size:- Length:1800mm, Width: 900mm, Height: 750mm, Top made of 25mm thick Pre-laminated Particle Board. PVC edge beading of 2 mm edges by Through Feed Machine. Provision of Cable manager as per L.H. or R.H. side requirement. Cable duct made of 0.8 mm CRCA Sheet. Leg/Side made of 25 mm thick PLPB fitted with Aluminium section of size 60X40 with grooving. Leg/Side Base & Top plate with profile cut made of M.S. plate 44 mm width & 4 mm thk with knock down fitting arrangement. All steel components are epoxy powder coated after seven tanks anti corrosion treatment of surface. The overall appearance of the product shall be as per DRAWING.</p>	02	Set				
04	<p><u>VISITOR CHAIR</u></p> <p>Size: Height Overall/Seat - 1080/480mm, Depth - 630mm, Width- 660mm : Under Structure cantilever type MS cold rolled close annealed Tube 1.6 mm thick. Hot pressed ply wood with steel T-Nuts for rigid fastening. Single piece die castes PP arm rest. Quality Latherite tapestry with double stitch. High density PU cushion. All steel components should be epoxy powder coated followed by seven tanks anti corrosion treatment of surface. The overall appearance of the product shall be as per DRAWING. Available in only Black Latherite.</p>	06	Nos				
05	<p><u>S.D.U 1200 HT</u></p> <p>Size: Height:1200mm,Width:900mm, Depth:400mm Body part made-up of prime quality cold rolled close annealed Sheet Use only MIG/TIG & Spot welding for fabrication. Top made of 18mm thick Pre-laminated Particle Board. Side Edges covered with PVC edge band on edge bending machine. Door set make lock. PVC handles. Doors in cold rolled close annealed M.S. Sheet. Doors are Top hung slide on roller bearing. All steel components are epoxy powder coated followed by seven tanks anti corrosion treatment of surface. The overall appearance of the product shall be as per DRAWING.</p>	22	Nos				
06	<p><u>PROPERTY COUNTER HELP DESK TABLE</u></p> <p>Overall Size:- Length:1200mm, Width: 600mm, Height: 750mm, Top made of 25mm thick Pre-laminated Particle Board. PVC edge beading of 2 mm edges by Through Feed Machine. Provision of Cable manager as per L.H. or R.H. side requirement. Cable duct made of 0.8 mm CRCA Sheet. Leg/Side made of 25 mm thick PLPB fitted with Aluminium section of size 60X40 with grooving. Leg/Side Base & Top plate with profile cut made of M.S. plate 44 mm width & 4 mm thk with knock down fitting arrangement. All steel components are epoxy powder coated after seven tanks anti corrosion treatment of surface. The overall appearance of the product shall be as per DRAWING.</p>	01	Nos				
<p style="text-align: center;">Seal and signature of the bidder</p> <p style="text-align: right;">60 Page</p>							

07	<p><u>HELP DESK CHAIR</u> Size:-Overall H: 830mm,Seat h: 460mm,D: 580mm,W: 535mm: Under Structure made of 19mm dia MS cold rolled close annealed tube 1.2 mm thick, duly powder coated after anti corrosion treatment of surface. Seat and back are made of 12mm thick Hot pressed ply wood with high density PU foam, upholstered with fine quality fabric. Arms Tubular. Steel components are epoxy powder coated followed by seven tanks anti corrosion pre-treatment of surface. Upholstery 0.6 Mtr. Overall appearance as per DRAWING.</p>	01	Nos				
08	<p><u>COFFEE TABLE ROUND</u> Size: 600 Dia. X 450 H mm • Top 25mm Thickness Prelaminated Partical Board finished with 2mm thick pvc edge band machine pasted. Structure bar rod frame to be fixed on metal pipe frame duly powder coated as per approved colour scheme</p>	10	Nos				
09	<p><u>COFFEE TABLE RECTANGLE</u> Size: 900 L X 600 D X 450 H mm • Top 25mm Thickness Prelaminated Partical Board finished with 2mm thick pvc edge band machine pasted. Structure bar rod frame to be fixed on metal pipe frame duly powder coated as per approved colour scheme</p>	02	Nos				
10	<p><u>CAFETARIA CHAIRS</u> Chair Pluto Without arm rest Size: Total Height-860mm, Width 400mm, Depth-500mm,Seat Height-450mm Under structure made out of MS cold rolled close annealed tube19mmx1.25mm thick. Fitted with PVC moulded shell. Steel components are epoxy powder coated followed by seven tanks anti corrosion pre-treatment of surface. Or Chrome plated.</p>	36	Nos				
11	<p><u>READING TABLES:</u> Providing and fixing Library Reading table with an overall sizes of library table is width 1350depth 900mm, height 750mm, 25mm thick prelaminate particle board with 2mm thick edge banding with thru feed machine hot melt glue. Frame Material 50x50 Square Tube</p>	15	Nos				
12	<p><u>READING TABLE (Plektrum Table)</u> Size - L 1053 X W - 1043 X H - 750 Providing and fixing Plektrum Table with , 25mm thick prelaminate particle board with 2mm thick edge banding with machine hot melt glue. Frame Material Round Tube 32 mm dia To be fixed on Metal Frame Rectangular Duly Powder Coted .</p>	06	Nos				

13	<p><u>ROUND TABLE</u></p> <p>Overall Dimension: 750mm dia x 750mm H • Top Made up of High Moisture Resistant 18mm Thick Prelaminated Partical Board . • Both side laminated, Color matching to running Color Scheme. • Edges finished with 2mm self glued hot pressed PVC Edge Biding by Rehau or equivalent. • Base Slides under Couches or seats for easy movement & Space Saving. • Base made up of Laser Cutted 8 mm Thick plate wielded with 30 mm dia MS Round pipe. • Base should be finished with Chrome. • Partical– Associate Brand or Equivalent</p>	05	Nos				
14	<p><u>PODIUM CHAIRS</u></p> <p>Size: Total Height-840mm, Depth 600mm, Width-575mm Seat Height:450mm. Under Structure cantilever type MS cold rolled close annealed Tube 1.6 mm thick. Hot pressed ply wood with steel T-Nuts for rigid fastening. Single piece integral skin PU arm rest. Quality tapestry. Seat and back covered with PP covers. High density PU moulded cushion. All steel components are epoxy powder coated followed by seven tanks anti corrosion treatment of surface. Upholstery 1.2 Mtr The overall appearance of the product shall be as per DRAWING.</p>	08	Nos				
15	<p><u>PODIUM TABLES</u></p> <p>Overall Size: 900 x 600 x 450 mm Legs shall made out of 7 5 x7 5 mm teal rood section as per DRAWING.Top rail shall be made of 7 0x22mm as per DRAWING.Top shall be made of 18mm veneer faced MDF board.Teak wood beading of 18mm shall be fitted as per approval.Polish- PUpolish shall be done.The overall appearance of the product shall be as per DRAWING</p>	04	Nos				
16	<p><u>CONFERENCE TABLE</u></p> <p>Size:- L-2700 W- 1200 x H750mmTop made of 25mm thick PLPB Top. Legs made of 18mm thick PLPB legs. Front Modesty Panel 18mm thick Pre laminated particle board. As per layout. All spec. as per Gem .</p>	04	Nos				
17	<p><u>TELE CONFERENCE TABLE</u></p> <p>Media Unit Overall size 2400mm L x 1200mm W x 750mm Table H Set of two tables Rectangle Table 1800mm L x 1200mm W x 750mm H Semicircle Table 1200mm L x 600mm W x 750mm H With provision of electric box on table top Base Metal Frame</p>	02	Nos				